

# **can-am**®

**QUADRY ŚREM**  
**KT RACING TEAM**  
AUTORYZOWANE CENTRUM BRP



**CAN-AM**  
**MAVERICK**

Accessories and Parts & Maintenance

2023





# CAN-AM MAVERICK

## ACCESSORIES

Roofs	5
Soft Cab Enclosure	6
Windshields & Mirrors	8
Doors	8
HMWPE Skid Plates	10
Bumpers & Guards	11
Seat Accessories	14
LinQ: Easy On, Easy Off Cargo	15
Racks & Storage	20
Lights	21
Audio & Communication Systems	25
Electrical & Electronic Accessories	26
Winches & Hitches	28
Performance	30
Trailerling	33
Apache Track Systems	34
ProMount Plows	36
Tires & Rims	39

## PARTS AND MAINTENANCE

Keep an eye on these parts	42
Genuine Parts	43
Lubricant & Oil Change Kit	48
Maintenance Products	49
Care Products	50

### CAN-AMOFFROAD.COM

© 2022 Bombardier Recreational Products Inc. (BRP). All rights reserved. ®, TM and the BRP logo are trademarks of BRP or its affiliates. †All other trademarks are the property of their respective owners. BRP reserves the right to discontinue or change specifications, prices, designs, features, models or equipment without incurring obligation. Some models depicted may include optional equipment. Product performance may vary depending on weather, temperature, altitude, driving ability and driver/passenger weight. Prices, if shown, are based on the manufacturer's suggested retail price. Dealers may sell at a different price. BRP recommends that all ATV-SSV drivers take a training course. See your dealer or call the ATV Safety Institute at 1-800-887-2887 (USA) or the Canadian Safety Council at 1-613-739-1535 (Canada). ATVs and SSVs can be hazardous to operate. Never carry passengers on any ATV-SSV not specifically designed by the manufacturer for such use. All adult-model Can-Am ATVs are category G ATVs (general-use models) intended for recreational and/or utility use by an operator age 16 or older. Carefully read the vehicle's operator's guide. Follow all instructional and safety material and observe applicable laws and regulations. ATVs and SSVs are for off-road use only; never ride on paved surfaces or public roads. For your safety, the operator and passenger(s) must wear a helmet, eye protection and applicable protective clothing. Always remember that riding, alcohol and drugs don't mix. Never engage in stunt driving. Avoid excessive speed and be particularly careful on difficult terrain. Always ride responsibly and safely. See your authorized BRP dealer for details and visit [can-am.brp.com](http://can-am.brp.com). Printed in Canada.



# CUSTOMIZING MADE EASY



**1**

Select the model.

**2**

Select the package.

**3**

Customize color, engine, and accessories (or accessory bundles) for your vehicle.

**4**

Click "Save" or "Send to dealer".

If you can dream it, you can build it. And ride it. Creating a Can-Am vehicle tailor-made for our riders' needs has never been easier. Visit [CanAmOffRoad.com](http://CanAmOffRoad.com) and follow the step-by-step above.

**BUILD  
YOURS NOW**





# ACCESSORIES MAVERICK

## BRP 2-YEAR LIMITED WARRANTY\*

For new Can-Am accessories, genuine parts, and co-branded products sold through BRP. Includes items installed by you or an authorized BRP dealer.

The limited warranty is subject to the exclusions, limitations of liabilities and all other terms and conditions of BRP's standard limited warranty. See the complete limited warranty applicable to your product, or contact your authorized Can-Am Off-Road dealer. Applicable only to BRP products purchased at authorized BRP dealers or distributors. This limited warranty may not apply to factory-installed parts and accessories. Always refer to the product-specific limited warranty. Some states and provinces do not allow for some disclaimers, limitations and exclusions and, as a result, you have other specific rights.



# ROOFS

<b>Sport Roof</b>	Maverick	<b>715005521</b>	<b>5 148 zł</b>
	Maverick MAX	<b>715003750</b>	<b>4 324 zł</b>



- Impact-resistant injected polypropylene.
- Excellent protection from the elements.
- Provides excellent downhill visibility.
- Windshield compatible.
- Standard on X rs model.
- Easy, tool-less installation and removal with quick-release ¼ turn fasteners and Velcro straps.

<b>ProVent Roof Module Kit</b>	Maverick, Maverick MAX	<b>715005279</b>	<b>1 206 zł</b>
--------------------------------	------------------------	------------------	-----------------



- Provides fresh air in the cab area.
- Optimal performance with full cab enclosure.
- 4 vents provide infinite adjustment of air flow for driver and passenger.
- Filter and pre-filter to limit dust intrusion.
- Easy cleaning of filter and pre-filter.
- Patent pending water management system to keep water out of cabin while maintaining air flow.
- Outer plug closes air intake completely for winter or heavy weather.
- Sport Roof requires ProVent Module Adapter Kit.
- Not compatible with roof mounted LED bars, roof racks or roof liners, Lonestar Roof, and Bimini tops.

<b>ProVent Roof Module Adapter Kit for Sport Roof</b> <i>(Not illustrated)</i>	Maverick	<b>715006199</b>	<b>486 zł</b>
	Maverick MAX	<b>715006371</b>	<b>486 zł</b>

- Adapter for fitting ProVent Roof Module Kit onto Maverick.
- Includes roof adapter and hardware.
- Requires ProVent Roof Module Kit (715005279).

<b>Aluminum Roof</b>	Maverick	■ <b>715004224</b> · Black	<b>3 053 zł</b>
		■ <b>715002900</b> · Silver	<b>3 088 zł</b>



- Formed aluminum roof 0.09" (2.3 mm) thick.
- Durable and lightweight.
- Sporty look.
- Windshield compatible.
- Easy and tool-less installation.

<b>Bimini<sup>†</sup> Roof with Sun Visor</b>	Maverick	<b>715002901</b>	<b>1 821 zł</b>
	Maverick MAX	<b>715003749</b>	<b>1 999 zł</b>



- Heavy-duty canvas made of UV-resistant solution-dyed polyester.
- Innovative soft top comes with a hard visor that allows for storage of rolled-up soft top.
- Easy, tool-less installation and removal with quick-release/turn fasteners and Velcro straps.

<b>Tinted Sun Visor</b>	Maverick, Maverick MAX	<b>715007098</b>	<b>1 446 zł</b>
-------------------------	------------------------	------------------	-----------------



- Tinted polycarbonate construction.
- Extra protection for driver and passenger from the sun.
- Not compatible with Aluminum Roof and Full Windshields.

<b>Lonestar Racing Aluminum Roof</b>	Maverick MAX	■ <b>715005508</b> · Hyper Silver	<b>4 613 zł</b>
		■ <b>715005507</b> · Black	<b>4 324 zł</b>
		■ <b>715004436</b> · Can-Am Red	<b>4 613 zł</b>
		■ <b>715005516</b> · Hyper Silver	<b>8 967 zł</b>
		■ <b>715005515</b> · Black	<b>8 924 zł</b>
		■ <b>715004341</b> · Can-Am Red	<b>9 268 zł</b>



- 0.083" (2.1 mm) thick aluminum roof.
- Durable and lightweight.
- Enhances the vehicle's racing appearance thanks to an authentic sporty look combined with unique graphics.
- Offers you protection from the elements with a personalized touch.
- Lower profile than other roofs.
- Compatible with Lonestar Racing Light Bar Racks.
- Not compatible with LinQ Pivoting Rack, Light Support Bar and Full Windshields.
- "Lonestar Racing for Can-Am" branded.
- Includes middle intrusion bars for installation



# SOFT CAB ENCLOSURE

<b>Soft Cab Enclosure</b>	Maverick (except X mr models)	<b>715003754</b>	<b>13 241 zł</b>
	Maverick MAX (except X mr models)	<b>715003755</b>	<b>18 413 zł</b>



- Protection for rider and passenger from the elements.
- For added cabin comfort, complete your cab enclosure with Cab Seal Kit.
- Includes:
  - Bimini roof with sun visor
  - Full windshield — hardcoated
  - Upper soft door panels
  - Front lower door panels
  - Soft rear window

<b>Cab Seal Kit</b> <i>(Not illustrated)</i>	Maverick	<b>715004433</b>	<b>258 zł</b>
	Maverick MAX	<b>715004434</b>	<b>175 zł</b>

- Prevents dirt, dust and wind infiltration in the cab area.
- Improves cabin comfort for driver and passenger.
- Recommended with Soft Cab Enclosures.

# WINDSHIELDS & MIRRORS

## Windshields

<b>PowerFlip Windshield</b>	Maverick, Maverick MAX	<b>715007097</b>	<b>8 635 zł</b>
-----------------------------	------------------------	------------------	-----------------



- The PowerFlip Windshield is equipped with electric cylinders that allow the rider to adjust the windshield opening at the touch of a button.
- Windshield is made of hardcoated polycarbonate with a rubber seal contour and a tinted top section.
- Allows you to quickly adapt to changing conditions by adjusting the windshield as you go.
- Can be fully opened for optimal visibility and ventilation, fully closed for maximum protection from the elements, and in between, you have an infinite number of opening possibilities depending on protection, visibility and air flow preferences.
- Compatible with Can-Am roofs.

<b>Windshield Wiper for PowerFlip Windshield</b>	Maverick, Maverick MAX	<b>715006310</b>	<b>4 957 zł</b>
--	------------------------	------------------	-----------------









- An ideal way to keep your windshield clear in rain or while riding through mud and water.
- Wiper from the top allows windshield pivoting. Includes single-speed wiper and washer-fluid dispenser.
- Wiper mechanism and washer-fluid dispenser perfectly concealed within the vehicle.
- Must be installed with the PowerFlip Windshield (sold separately).

<b>Provent Windshield</b>	Maverick, Maverick MAX	<b>715005277</b>	<b>5 246 zł</b>
---------------------------	------------------------	------------------	-----------------



- High-impact-resistant Quantum hardcoated polycarbonate full windshield.
- Controllable vents to manage air flow.
- Optimal performance with full cab enclosure.
- Channels air into the cabin, defogs windshield, fully closes to eliminate air flow.
- One upper vent and one lower vent with pre-filters.
- Formed polycarbonate construction for enhanced rigidity.
- Provides excellent optical clarity and better abrasion resistance.
- Protects driver and passenger from the elements.
- Quick and easy tool-less installation or removal.
- Not compatible with wiper kits and Wet Sounds Stealth 6 Ultra HD Can-Am Edition Sound Bar.
- Upper vent channels air into the cabin.
- Lower vents defog windshield.



<b>Glass Windshield</b>	Maverick, Maverick MAX	<b>715008859</b>	<b>6 599 zł</b>
	<ul style="list-style-type: none"> <li>▪ Curved and laminated glass full windshield.</li> <li>▪ Seals firmly against the cage and protects rider and passenger from the elements.</li> <li>▪ Provides the best optical clarity and abrasion resistance.</li> <li>▪ Must be used with Windshield Wiper &amp; Washer Kit to maintain clear visibility during severe riding conditions, such as mud riding.</li> <li>▪ Recommended to use with rear wind protection to maximize comfort for passenger.</li> </ul>		
<b>Glass Windshield with Wiper &amp; Washer Kit</b>	Maverick, Maverick MAX	<b>715008858</b>	<b>9 594 zł</b>
	<ul style="list-style-type: none"> <li>▪ Complete kit that includes a curved and laminated glass windshield with a single-speed wiper and washer fluid dispenser.</li> <li>▪ Seals firmly against the cage and protects rider and passenger from the elements.</li> <li>▪ An ideal way to keep your windshield clear in rain, or while riding through mud and water.</li> <li>▪ Recommended to use with rear wind protection to maximize comfort for passenger.</li> </ul>		
<b>Full Windshield</b>	Maverick, Maverick MAX	<b>715002907</b>	<b>2 817 zł</b>
	<ul style="list-style-type: none"> <li>▪ High-impact-resistant durable polycarbonate full windshield.</li> <li>▪ Formed polycarbonate construction for enhanced rigidity.</li> <li>▪ Formulated to be non-yellowing, non-crazing, non-cracking with excellent UV resistance and optical clarity.</li> <li>▪ Protects driver and passenger from the elements.</li> <li>▪ Quick and easy tool-less installation or removal.</li> <li>▪ Recommended to use with rear wind protection to maximize comfort for passenger.</li> </ul>		
<b>Full Windshield – Hardcoated</b>	Maverick, Maverick MAX	<b>715004417</b>	<b>4 115 zł</b>
	<ul style="list-style-type: none"> <li>▪ High-impact-resistant Quantum hardcoated polycarbonate full windshield.</li> <li>▪ Formed polycarbonate construction for enhanced rigidity.</li> <li>▪ Provides excellent optical clarity and better abrasion resistance.</li> <li>▪ Protects driver and passenger from the elements.</li> <li>▪ Quick and easy tool-less installation or removal.</li> <li>▪ Recommended to use with rear wind protection to maximize comfort for passenger.</li> <li>▪ Can be used with the Windshield Wiper and Washer Kit (715004762).</li> </ul>		
	Maverick, Maverick MAX Fit with Full Windshield Hardcoated (715004417)	<b>715004762</b>	<b>3 869 zł</b>
<b>Windshield Wiper &amp; Washer Kit</b>	Maverick, Maverick MAX Fit with Glass Windshield (715008859)	<b>715003282</b>	<b>3 869 zł</b>
	<ul style="list-style-type: none"> <li>▪ An ideal way to keep your windshield clear in rain, or while riding through mud and water.</li> <li>▪ Includes single-speed wiper and washer fluid dispenser.</li> <li>▪ Wiper mechanism and washer fluid dispenser perfectly concealed within the vehicle.</li> </ul>		
<b>Half Windshield</b>	Maverick, Maverick MAX	<input type="checkbox"/> <b>715002909</b> · Clear <input checked="" type="checkbox"/> <b>715004291</b> · Tinted	<b>1 901 zł</b> <b>2 067 zł</b>
	<ul style="list-style-type: none"> <li>▪ High-impact-resistant durable polycarbonate half windshield.</li> <li>▪ Formed polycarbonate construction for enhanced rigidity.</li> <li>▪ Formulated to be non-yellowing, non-crazing, non-cracking with excellent UV resistance and optical clarity.</li> <li>▪ Protects driver and passenger from the elements.</li> <li>▪ Features reverse angle lip to deflect air flow.</li> <li>▪ Quick and easy tool-less installation or removal.</li> </ul>		



## Mirrors

### Rear Mirror & Camera Monitor

Maverick, Maverick MAX

715004905 **2 700 zł**



- Fully waterproof rear view camera and monitor kit.
- Multiple camera feeds can be seen with the rear view camera, to see what you need.
- Unit replaces stock rear view mirror (screen is integrated in the unit's replacement rear view mirror).
- Camera uses infrared light for night vision capabilities.

### Side Mirrors

Maverick, Maverick MAX

715004236 **1 556 zł**

• For stock quarter doors

715005315 **1 556 zł**

• For aluminum doors



- Rugged cast aluminum mount with black nylon cover.
- Multi-position adjustable ball-joint mounted mirrors.
- Convex optics for a wide viewing angle.
- Spring-loaded pivots let mirrors fold back completely.
- Door mounted.
- Compatible with Upper Soft Door Panels.
- Sold in pairs.

### Racing Side Mirrors

Maverick, Maverick MAX

715002898 **1 310 zł**



- Race-inspired design features rugged black nylon ½ construction with coated cast-aluminum mount.
- Dual adjustment provides optimal field of view (FOV).
- Multi-position adjustable ball-joint mounted mirrors.
- Flat optics deliver improved distance perception.
- Spring-loaded pivots let mirrors fold back completely.
- Not compatible with Lonestar Racing Light Racks, Upper Soft Door Panels or Flip Audio Roof Kit (715007131).
- Sold in pairs.

### Rally Side Mirrors

Maverick, Maverick MAX

715005262 **1 415 zł**



- Sleek design with unique racing style.
- High-quality black molded aluminum for extreme durability.
- 4" (10 cm) convex surface provides a wider field of view and better visibility around the unit.
- Can be installed at any height on the cage A-pillar for optimized rider vision.
- Multi-position adjustable ball-joint-mounted mirrors.
- Spring-loaded pivots let mirrors fold back completely.
- Sold in pairs.
- Not compatible with Glass Windshield.

## DOORS

### Aluminum Half Doors

Maverick, Maverick MAX

715007971 - Front **4 348 zł**

Maverick MAX

715007972 - Rear **4 348 zł**



- Lightweight half doors made of formed 5/64" (2 mm) thick aluminum.
- Smooth finish.
- Engineered for maximum rigidity and durability.
- Designed for a perfect fit and seamless integration with the vehicle's lines.
- Contoured with a thick seal for better protection from the elements.
- Easy installation using the standard door frame.
- Includes the easy-to-operate Deluxe Door Handles.
- Compatible with the Upper Soft Door Panels, the Window Nets and Upper Door Storage Bags.
- Not compatible with the Lower Door Panel Storage Bags.
- Sold in pairs.



<b>Deluxe Door Handles</b>	Maverick, Maverick MAX	715004758 · Front	1 052 zł
	Maverick MAX	715004860 · Rear	1 052 zł

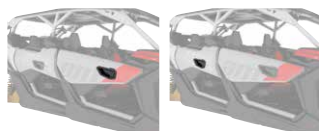

- Convert the standard door straps into easy-to-access door handles.
- Include inside and outside handles for each door.
- Greatly facilitate door opening.
- Standard on accessory Aluminum Half Doors.
- Sold in pairs.

<b>Lower Door Panels</b>	Maverick, Maverick MAX	715002903 · Front	2 159 zł
		715003751 · Rear	2 190 zł

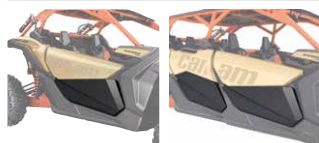

- Robust injection-molded polypropylene construction designed to match vehicle.
- Extend stock doors at bottom to protect and seal cab area.
- A great-looking add-on.
- Easy and quick installation.
- Sold in pairs.

## Doors & Rear Wind Protection

<b>Window Nets</b>	Maverick	715006693 · Front	1 033 zł
	Maverick MAX	715004694 · Front	966 zł
	Maverick MAX	715006700 · Rear	1 033 zł



- Window mesh screen for added protection from wind.
- Can be easily lowered in seconds.
- Sold in pairs.
- Not compatible with Can-Am Audio Roof.

<b>Upper Soft Door Panels</b>	Maverick (except X mr models)	715008091 · 2 doors	4 662 zł
	Maverick MAX (except X mr models)	715008092 · 4 doors	8 942 zł



- Weather-resistant panels reinforced with aluminum frame offer good protection from the elements.
- Extend stock quarter doors at the top.
- Made of heavy-duty UV-resistant solution-dyed polyester canvas for excellent resistance to tear and abrasion.
- Zip-down windows made of laminated polished vinyl material for added ventilation.
- To be combined with the Lower Door Panels to obtain complete door kits for your vehicle.
- Not compatible with Racing Side Mirrors and Can-Am Audio Roof.

<b>Rear Wind Screen</b>	Maverick, Maverick MAX (except X mr models)	715006701	658 zł
-------------------------	---	-----------	--------



- Full rear mesh screen reduces windshield backdraft for added cabin comfort.
- Installs quickly and easily on roll cage.
- Large white Can-Am logo on black mesh.

<b>Rear Polycarbonate Window</b>	Maverick, Maverick MAX (except X mr models)	715006387	1 901 zł
----------------------------------	---	-----------	----------



- High-impact-resistant polycarbonate window.
- Blocks windshield backdraft or dust and rain from entering for added cabin comfort.
- Quick and easy tool-less installation.
- Ready for MTX Audio System Rear Speakers.

<b>Soft Rear Window</b>	Maverick, Maverick MAX (except X mr models)	715006702	658 zł
-------------------------	---	-----------	--------



- Clear, flexible window made from transparent vinyl.
- Resists cold-cracking to -4°F (-20 °C).
- Ideal for preventing backdraft of dust or rain in harsh environments.
- Quick tool-less installation.



# HMWPE SKID PLATES

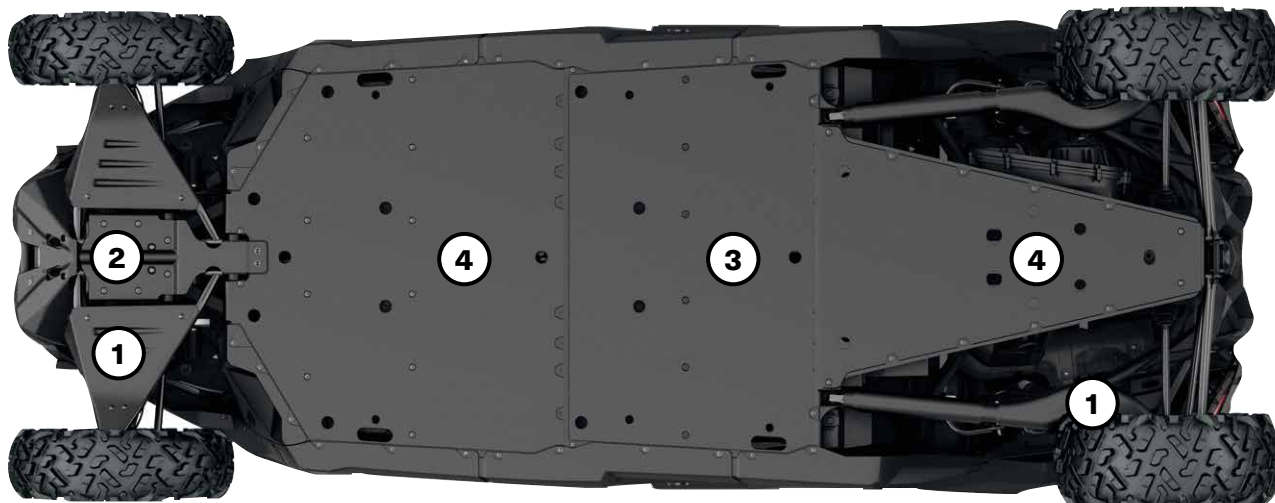

Our plastic plates glide smoothly and silently over obstacles, offering great protection in rough terrain. Made of abrasion-resistant thermoformed  $\frac{3}{8}$ " (10 mm) thick High Molecular Weight Polyethylene (HMWPE).

- Lighter than aluminum.
- Superior stress crack resistance.
- High-impact strength.

## MAVERICK, MAVERICK MAX

HMWPE Skid Plates are standard on Maverick X rc models.	Maverick 64" models	Maverick Max 64" models	Maverick, Maverick Max 72" models (except Base models)	Maverick Base 72" models	Maverick Max Base 72" models
<b>HMWPE Skid Plate Protection Kit</b>					
	715003713 2 511 zł	715003747 2 511 zł	715003718 1 557 zł	715006767 1 557 zł	715006769 1 557 zł
<b>Individual HMWPE Skid Plates</b>					
① HMWPE Front A-Arm and Trailing Arm Protectors	715002905	715002905	715003552	715003552	715003552
② HMWPE Front Skid Plate	715003933	715003933	715003933	715003933	715003933
③ HMWPE Central Skid Plate	—	715003731	Standard on X rc models only	—	715003731
④ HMWPE Underbelly Plate	715004904	715004904	Standard on X rc models only	715004904	715004904

715002905 1 450 zł  
 715003933 533 zł  
 715004904 2 431 zł  
 715003731 1 152 zł  
 715003552 1 557 zł

# BUMPERS & GUARDS

## Bumpers

### Front Pre-Runner Bumper

Maverick, Maverick MAX

■ 715002878 · Black 1 821 zł  
■ 715003433 · Can-Am Red 2 214 zł



- Made of 1.5" (3.8 cm) diameter steel tubing with a 1/8" (3 mm) aluminum plate for extra durability.
- Inside and outside anti-corrosion coating with durable powder coat finish.
- Added heavy-duty protection in extreme driving conditions.
- Integrated winch mounting plate and mount points for lights.

### Rear Pre-Runner Bumper

Maverick, Maverick MAX

■ 715002880 · Black 1 858 zł  
■ 715003436 · Can-Am Red 2 214 zł



- Extra-durable 1.5" (3.8 cm) diameter steel tubing with a 1/8" (3 mm) aluminum plate.
- Inside and outside anti-corrosion coating with durable powder coat finish.
- Protects vehicle bodywork and exhaust system.
- Rear Receiver Hitch compatible.
- Required for installation of the Rear Cage Extension.

### Dune Front Bumper

Maverick, Maverick MAX

■ 715002961 · Black 1 575 zł  
■ 715003432 · Can-Am Red 1 858 zł



- Made of 1.5" (3.8 cm) diameter aluminum tubing with a 1/8" (3 mm) aluminum plate.
- Inside and outside anti-corrosion coating with durable powder coat finish.
- Provides added protection without sacrificing the agility and performance advantages of a lighter weight design.
- Features a more pronounced attack angle and integrated mounting points for lights.
- Not winch compatible.

### Dune Rear Bumper

Maverick, Maverick MAX 2021 & prior  
Maverick, Maverick MAX 2022 & up

■ 715002962 · Black 1 575 zł  
■ 715003437 · Can-Am Red 1 858 zł  
■ 715009242 · Black 1 575 zł



- Made of 1.5" (3.8 cm) diameter aluminum tubing with a 1/8" (3 mm) aluminum plate.
- Inside and outside anti-corrosion coating with durable powder coat finish.
- Provides added protection without sacrificing the agility and performance advantages of a lighter weight design.
- Protects vehicle bodywork and exhaust system.
- Rear hitch compatible.
- Not compatible with Rear Cage Extension and Lonestar Racing Spare Tire Holder.

### X rc/X mr Front Bumper

Maverick, Maverick MAX

■ 715004788 · Black 2 454 zł



- Made of 1.5" (3.8 cm) diameter steel tubing with a 1/8" (3 mm) aluminum plate.
- Inside and outside anti-corrosion coating with durable powder coat finish on steel tubing.
- Offers all the essential features required for technical driving: low front-end protection, support base for winch installation and integrated tow hook.
- Standard on Maverick X rc and X mr models.
- Not compatible with winches with steel cable.

### Lonestar Racing Front Bumper

Maverick, Maverick MAX  
(not compatible X mr and X rc models)  
Maverick, Maverick MAX

■ 715005510 · Hyper Silver 2 423 zł  
■ 715005509 · Black 2 214 zł  
■ 715004161 · Can-Am Red 2 454 zł



- Made of 1.5" (3.8 cm) diameter steel tubing with durable powder coat finish and a 1/8" (3 mm) thick aluminum plate for added vehicle-front protection in extreme driving conditions.
- Sleek styling enhances the vehicle's race-inspired look.
- Not winch compatible.
- Not compatible with 10" (25 cm) Baja Designs OnX6 LED Light Bar.
- Not compatible with stock Smart-Shox



### Lonestar Racing Rear Bumper

Maverick, Maverick MAX 2021 & prior

■ 715005512 · Hyper Silver 2 632 zł  
■ 715005511 · Black 2 331 zł  
■ 715004162 · Can-Am Red 2 632 zł



- Made of 1.5" (3.8 cm) diameter steel tubing with durable powder coat finish.
- Provides additional vehicle-rear bodywork and exhaust system protection in extreme driving conditions.
- Sleek styling enhances the vehicle's race-inspired look.
- Compatible with Lonestar Racing Spare Tire Holder.
- Not hitch compatible.

### S3<sup>+</sup> Front Bumper

Maverick, Maverick MAX

■ 715004867 · Black 2 694 zł



- Made of 1.5" (3.8 cm) diameter steel tubing with a 1/8" (3 mm) aluminum plate for extra durability.
- Inside and outside anti-corrosion coating with durable powder coat finish.
- Added heavy-duty protection in extreme driving conditions.
- Integrated winch support plate and mount points for lights.
- Hook support anchor allows you to keep the winch hook within easy reach when riding in deep mud.
- "S3 for Can-Am" branded.
- Winch not included.

### S3 Rear Bumper

Maverick, Maverick MAX 2021 & prior

■ 715004869 · Black 3 653 zł  
■ 715005232 · Can-Am Red 3 690 zł



- Made of extra-durable 1.5" (3.8 cm) diameter steel tubing.
- Inside and outside anti-corrosion coating with durable powder coat finish.
- Added heavy-duty protection in extreme driving conditions—protects vehicle bodywork and exhaust system.
- Permits installation of a winch at a higher location to improve accessibility in muddy conditions.
- "S3 for Can-Am" branded.
- Engineered to sustain heavy winch loads without damaging the vehicle's frame.
- Compatible with Can-Am HD and WARN VRX winches—Rear Winch Harness 715006007 is required to install a winch on the bumper.
- Includes a robust recovery hook to facilitate vehicle recovery.
- Winch not included.
- Not EC compliant.

## Rock Sliders

### Rock Sliders

Maverick (except X rc)

■ 715002963 · Black 1 575 zł  
■ 715003438 · Can-Am Red 1 913 zł  
■ 715003730 · Black 2 331 zł  
■ 715003888 · Can-Am Red 2 632 zł



- Made of heavy-duty 1.5" (3.8 cm) diameter steel tubing.
- Inside and outside anti-corrosion coating with durable powder coat finish.
- Protect vehicle's sides and undercarriage against large obstacles.
- Support plate adds rigidity and style.
- Sold in pairs.

### X rc UHMWPE Rock Sliders

Maverick

■ 715004730 3 881 zł

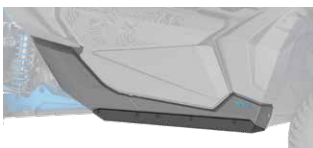

- Robust 1/4" (6 mm) UHMWPE construction.
- Include lower body panels and brackets for installation.
- Protect vehicle's sides and undercarriage against large obstacles.
- Lodge tight up against vehicle body for better clearance from obstacles.
- Slide smoothly over obstacles.
- Sold in pairs.

### Lonestar Racing Rock Sliders

Maverick (except X rc models)

■ 715005514 · Hyper Silver 2 214 zł  
■ 715008845 · Black 2 067 zł  
■ 715008846 · Can-Am Red 2 325 zł  
■ 715005518 · Hyper Silver 4 287 zł  
■ 715008847 · Black 4 127 zł  
■ 715008848 · Can-Am Red 4 385 zł



- Race-engineered to Lonestar Racing's trademark standards for toughness, these stylishly crafted accessories will also enhance your vehicle with visual impact.
- Made of 1.5" (3.8 cm) diameter steel tubing with durable powder coat finish.
- Essential protection for your vehicle's sides from large obstacles.
- Sold in pairs.

## Intrusion Bars

### Front Intrusion Bar

Maverick, Maverick MAX

■ 715002889 · Black 2 091 zł  
■ 715003435 · Can-Am Red 2 399 zł



- Matches vehicle styling.
- Inside and outside anti-corrosion coating with durable powder coat finish steel intrusion bar.
- Tube design reduces obstructed lines of sight and blind spots for better visibility.
- Not compatible with windshields and Lonestar Racing Aluminum Roof.

### Lonestar Racing Front Intrusion Bar

Maverick, Maverick MAX

■ 715006342 · Hyper Silver 2 694 zł  
■ 715003916 · Black 2 399 zł  
■ 715004163 · Can-Am Red 2 694 zł



- Made of 1.5" (3.8 cm) diameter steel tubing with durable powder coat finish.
- Enhances the racing look of the vehicle.
- Compatible with Lonestar Racing Aluminum Roof only.
- Not compatible with windshields.

### Lonestar Racing Rear Intrusion Bar

Maverick (except X mr models), Maverick MAX

■ 715003918 · Black 1 913 zł  
■ 715004164 · Can-Am Red 2 214 zł



- Made of 1.5" (3.8 cm) diameter steel tubing with durable powder coat finish.
- Sleek styling enhances the vehicle's race-inspired look.
- Required for the installation of the Lonestar Racing Spare Tire Holder.
- Not compatible with LinQ mounted accessories and Pre-Filter in the cargo bed.

## Other Accessories

### Fender Flares

Maverick, Maverick MAX

715002973 1 858 zł



- Extended fender flares made from injection-molded polypropylene.
- Keep mud and debris out of vehicle.
- Designed for quick and easy installation.
- Include front and rear extensions and mounting hardware.

### Lonestar Racing Spare Tire Holder

Maverick, Maverick MAX 2021 & prior (except X mr models)

■ 715006344 · Hyper Silver 1 612 zł  
■ 715003922 · Black 1 366 zł  
■ 715004166 · Can-Am Red 1 655 zł



- Made of 1.5" (3.8 cm) diameter steel tubing with durable powder coat finish.
- Adjustable height to fit Can-Am tires up to 30 in.
- Requires Lonestar Racing Rear Bumper and Lonestar Racing Rear Intrusion Bar for installation.
- Cannot hold the Pro Armor Quickshot Wheel Jack and Off-Road Screw Jack.
- Wheel not included.
- Not compatible with the S&B Particle Separator and LinQ accessories intended for the rear of the vehicle.

### Lonestar Racing Number Plate Holder

Maverick, Maverick MAX

715003943 1 120 zł



- Includes a pair of sturdy aluminum number plates that mount on either side of the vehicle rear.
- Not compatible with LinQ Pivoting Rack.
- Numbered decals are available through SCS Unlimited.
- Styling enhances the vehicle's race-inspired look while adding a personal touch.
- Black background.



### Rear Cage Extension

Maverick (except X mr models), Maverick MAX

■ **715008298** · Black  
■ **715008299** · Can-Am Red

**1 913 zł**



- Durable 1.5" (3.8 cm) diameter steel tubing.
- Inside and outside anti-corrosion coating with durable powder coat finish.
- Allows holding a spare tire in place (wheel not included).
- Custom tie-down strap for fast tire installation or removal.
- Rear Pre-Runner Bumper required for installation.
- Not compatible with LinQ Pivoting Rack, cargo boxes (except LinQ 20 gal (73 L)
- Deluxe Modular Bag and Lonestar Racing roofs.

### S3 Rear Pull Plate

Maverick, Maverick MAX 2021 & prior

■ **715004870** · Black  
■ **715005233** · Can-Am Red

**763 zł**



- Offers a solid place to hook onto in case towing is needed.
- Allows you to attach most straps and hooks.
- "S3 for Can-Am" branded.

## SEAT ACCESSORIES

### 4-Point Harness

Maverick, Maverick MAX

**715008033** · Driver **1 458zł**

**715008034** · Passenger **1 218 zł**



- Exclusive controlled decelerator technology (patent pending) absorbs additional energy in case of accident.
- Designed to offer maximum riding comfort.
- Easy one-click latch and release.
- Patent pending.
- Not EC compliant.

### Retractable 4-Point Harness

Maverick, Maverick MAX

**715005021** · Driver **1 458 zł**

**715005022** · Passenger **1 218 zł**



- Convenient harness allows you to move freely in your seat, and at the same time fully benefit from the extra support given by the 4-point attachments.
- Makes it easier to buckle up and requires fewer adjustments when switching passenger or driver.
- Retractor Protector (707900653) is required for installation on front seats of MAX models.
- Compatible with rear passenger seats on MAX models.
- Standard on select Maverick models.

### Retractor Protector

(Not illustrated)

Maverick MAX

**707900653**

**517 zł**

- Protective pad required for the installation of the Retractable 4-Point Harness on front seat of MAX models.
- Protects the passengers from the retractor mechanism.
- Sold individually.

### Seat Belt Shoulder Pads

Maverick, Maverick MAX

**715002894**

**238 zł**



- Provide additional riding comfort by preventing seat belt from rubbing on neck and shoulder.
- Fit with stock 3-point seat belts and 4 point harness.
- Easy Velcro installation.
- Can-Am branded.
- Sold in pairs for driver and passenger.

# LINQ: EASY ON, EASY OFF CARGO

## MAVERICK'S LINQ ACCESSORIES

### Mounting location and requirements

<ul style="list-style-type: none"> <li>No tools needed: Quickly install and remove accessories by hand</li> <li>Equip your Can-Am for specialized tasks in no time</li> <li>Sturdy mounting system that holds up to the roughest terrain</li> </ul>	Standard Cargo Bed	LinQ Pivoting Rack 715008295/715008296	Adventure Roof Rack 715003868/715006225
<b>LinQ Accessories with 16" Base</b> <ul style="list-style-type: none"> <li>LinQ anchors mounted 16 inches apart, center-to-center.</li> <li>Lower loading capacity than the LinQ with 36" base accessories.</li> <li>Can be used on Can-Am ATV and SSV vehicles, Can-Am Spyder and Ryker vehicles, Sea-Doo watercraft and Ski-Doo snowmobiles.</li> </ul>			
<b>LinQ 4.2 Gal Cooler</b> 295100698 • Gray 219400964 • Black	LinQ Anchor Adapter Kit 715004960	LinQ Anchor Adapter Kit 715004960	LinQ Base Installation Kit 715008125
<b>LinQ Tool Kit</b> 715006829			No further requirements
<b>LinQ Tool Box</b> 715008111			LinQ Base Installation Kit 715008125
<b>LinQ SR 5.5 Gal (21 L) Bag</b> 860202449			
<b>LinQ 4.5 Gal (17 L) Sport Bag</b> 860202447			
<b>LinQ Modular Box</b> 715005494 • (10 L) 715007112 • (20 L) 715006830 • (30 L)			No further requirements
<b>LinQ Roll-Top Bag</b> 715008110			LinQ Base Installation Kit 715008125
<b>LinQ Accessories with 36" Base</b> <ul style="list-style-type: none"> <li>Mount on LinQ racks often used by Can-Am ORV vehicles.</li> <li>Higher loading capacity than the LinQ with 16" base accessories.</li> <li>Usage is limited to Can-Am ORV vehicles.</li> </ul>			
<b>LinQ 12 Gal (45 L) Cargo Box</b> 715003879	No compatibility	No further requirements	No compatibility
<b>LinQ 23 Gal (86 L) Trunk Box</b> 715008749	No further requirements *Not compatible if the LinQ Pivoting Rack is installed.		
<b>LinQ 32 Gal (121 L) Trunk Box</b> 715001748			
<b>LinQ 11.5 Gal (43 L) Audio Cargo Box</b> 715003018	No further requirements		
<b>LinQ 8 Gal (30 L) Cooler Box</b> 715004778 • Black 715004698 • Gray	No further requirements		
<b>LinQ Premium Storage Bag by OGIO<sup>®</sup></b> 715002923 • Black	No further requirements		
<b>LinQ Heavy Duty Basket</b> 715001215	No further requirements		
<b>LinQ Low Profile Basket</b> 715004282			
<b>LinQ Holders</b>			
<b>LinQ Gear Grips</b> 715005340	No further requirements	No further requirements	Side wall installation LinQ Adapters 715003058
<b>LinQ Tool Holder</b> 715007358			



## LinQ Accessories with 16" base

<b>LinQ Modular Box</b>	Maverick, Maverick MAX	<b>715005494</b> · (10 L) <b>720 zł</b> <b>715007112</b> · (20 L) <b>831 zł</b> <b>715006830</b> · (30 L) <b>923 zł</b>
	<ul style="list-style-type: none"> <li>Modular LinQ cargo boxes with 10 L (2.6 gal) capacity.</li> <li>Allows stacking of other modular boxes to always have the right gear accessible.</li> <li>Always have the right box size to fit everything.</li> <li>Can be installed on any LinQ base with a 16" width.</li> <li>See table for installation location and requirements.</li> </ul>	
<b>Thermal Insert for LinQ Modular Box (10 L)</b>	Maverick, Maverick MAX	<b>219401110</b> <b>290 zł</b>
	<ul style="list-style-type: none"> <li>Insulated liner.</li> <li>Fits very well in the LinQ Modular Box (10 L).</li> <li>Can contain five 473 ml cans or six 355 ml cans.</li> </ul>	
<b>LinQ Tool Box</b>	Maverick, Maverick MAX	<b>715008111</b> <b>904 zł</b>
	<ul style="list-style-type: none"> <li>High precision injected HDPE construction provides rigidity and durability.</li> <li>5 gal (19 L) maximum capacity.</li> <li>Weather-resistant, sealed and lockable cover.</li> <li>Easy one-second on/off tool-less system.</li> <li>All the benefits of LinQ—simple, fast and secure.</li> <li>See table for installation location and requirements.</li> </ul>	
<b>LinQ Tool Kit</b>	Maverick, Maverick MAX	<b>715006829</b> <b>1 605 zł</b>
	<ul style="list-style-type: none"> <li>Includes: <ul style="list-style-type: none"> <li>Cutter pliers</li> <li>Long-nose pliers</li> <li>Locking pliers</li> <li>Ratchet wrench 3/8" drive</li> <li>6" ratchet extension</li> <li>Integrated CVT belt storage location (belt not included)</li> <li>Long-socket 19 mm 3/8" drive - 6pts</li> <li>Socket 18 mm 3/8" drive</li> <li>Long-socket 17 mm 3/8" drive - 6pts</li> <li>Socket 15 mm 3/8" drive</li> <li>Socket 13 mm 3/8" drive</li> <li>Socket 10 mm 3/8" drive</li> <li>Socket 8 mm 3/8" drive</li> <li>Combined wrench 19 mm</li> <li>Combined wrench 18 mm</li> <li>Combined wrench 15 mm</li> <li>Combined wrench 13 mm</li> <li>Combined wrench 10 mm</li> <li>Combined wrench 8 mm</li> <li>Socket Torx T30 3/8" drive</li> <li>Socket Torx T20 3/8" drive</li> <li>Breaker bar 3/8" drive</li> </ul> </li> <li>See table for installation location and requirements</li> </ul>	
<b>LinQ 4.2 Gal (16 L) Cooler</b>	Maverick, Maverick MAX	<b>219400964</b> · Black <b>1 882 zł</b> <b>295100698</b> · Gray
	<ul style="list-style-type: none"> <li>All the benefits of LinQ—simple, fast and secure.</li> <li>Rotomolded construction for exceptional rigidity and durability.</li> <li>Premium-quality foam insulation for optimal ice retention.</li> <li>Uses LinQ mounting system (Patent US 8777531 and US 8875830).</li> <li>Easy one-second on/off tool-less system.</li> <li>See table for installation location and requirements.</li> </ul>	
<b>LinQ 4.5 Gal (17 L) Sport Bag</b>	Maverick, Maverick MAX	<b>860202447</b> <b>1 058 zł</b>
	<ul style="list-style-type: none"> <li>17-liter (4.5 US gallon, 1,037 cu. in.) capacity.</li> <li>Rigid bottom, semi-rigid top.</li> <li>See table for installation location and requirements.</li> </ul>	
<b>SR 5.5 Gal (21 L) LinQ Bag</b>	Maverick, Maverick MAX	<b>860202449</b> <b>1 144 zł</b>
	<ul style="list-style-type: none"> <li>All the benefits of LinQ—simple, fast and secure.</li> <li>Semi-rigid expandable bag.</li> <li>5.5 gal (21 L) capacity.</li> <li>Utilizes LinQ mounting system (Patent US 8777531 and US 8875830).</li> <li>Easy one-second on/off tool-less system.</li> <li>See table for installation location and requirements.</li> </ul>	

**LinQ Roll-Top Bag**

Maverick, Maverick MAX

**715008110**

**1 175 zł**



- Fully waterproof roll-top dry bag will securely store and confine your equipment.
- LinQ mounted using heavy-duty rigid plastic base.
- High capacity storage solution (40 L).
- Bottom foam liner for additional equipment protection.
- Integrated handle for easy transportation on/off the vehicle.
- See table for installation location and requirements.

**LinQ Accessories with 36" base**

**LinQ 12 Gal (45 L) Cargo Box**

Maverick, Maverick MAX

**715003879**

**1 661 zł**



- LinQ mounted for easy-on, easy-off installation.
- Holds cargo safely and securely while riding.
- See table for installation location and requirements.

**LinQ 23 Gal (86 L) Trunk Box**

Maverick (except X mr models), Maverick MAX

**715008749**

**1 907 zł**



- LinQ mounted for easy-on, easy-off installation.
- Holds cargo safely and securely while riding.
- See table for installation location and requirements.

**LinQ 32 Gal (121 L) Trunk Box**

Maverick (except X mr models), Maverick MAX

**715001748**

**2 700 zł**



- Equipped with the LinQ System, the rear trunk box plugs in and out in seconds.
- 32 gal (121 L) load capacity with unobstructed space to maximize storage room and access to the trunk's interior.
- Made of injection-molded polyethylene, double walled in critical areas.
- The fully sealed lid protects your belongings from dust, moisture and the elements.
- No rear tail light.
- Trunk Box Panels available in many colors to match your vehicle (sold separately).
- See table for installation location and requirements.

**LinQ 32 Gal (121 L) Trunk Box Panels**

Fit with LinQ 32 Gal (121 L) Trunk Box  
EUROPEAN VERSION (EC compliant)

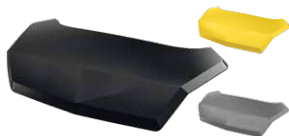

- Color panels to match the LinQ 32 gal (121 L) Trunk Box to your vehicle.
- No rear tail light

■ <b>715001397</b> · Black	<b>329 zł</b>	■ <b>715006122</b> · Manta Green	<b>337 zł</b>
■ <b>715001398</b> · Yellow	<b>329 zł</b>	■ <b>715006123</b> · Orange Crush	<b>337 zł</b>
■ <b>715002483</b> · White	<b>329 zł</b>	■ <b>715006124</b> · Viper Red	<b>337 zł</b>
■ <b>715006121</b> · Can-Am Red	<b>337 zł</b>		

**LinQ 8 Gal (30 L) Cooler Box**

Maverick, Maverick MAX

**715004778** · Black  
**715004698** · Gray

**2 270 zł**



- LinQ mounted for easy-on, easy-off installation.
- Rotomolded construction provides exceptional rigidity and durability.
- Premium-quality foam insulation for optimal ice retention.
- Integrated, fully removable compartment protects food.
- Robust rubber latches keep the cover tightly closed.
- Weather-resistant.
- Convenient drain plug.
- See table for installation location and requirements.



<b>LinQ 11.5 Gal (43 L) Audio Cargo Box</b>	Maverick, Maverick MAX	715003018	4 176 zł
	<ul style="list-style-type: none"> <li>▪ An affordable and quick solution for adding music and storage to your next ride.</li> <li>▪ The rear installation does not use up any cab space and allows easy listening at an average speed.</li> <li>▪ Mounts on/off easily to hold/carry cargo safely and securely.</li> <li>▪ Backlit control panel perfect for night riding.</li> <li>▪ Water-resistant speakers.</li> <li>▪ The Bluetooth<sup>®</sup> enabled receiver and 6.5" (16.5 cm) speakers are smartly concealed and integrated in the cover.</li> <li>▪ Automatic shut-off function protects your battery by turning the system off after 10 minutes of inactivity.</li> <li>▪ See table for installation location and requirements.</li> </ul>		
<b>LinQ Heavy-Duty Basket</b>	Maverick, Maverick MAX	715001215	1 390 zł
	<ul style="list-style-type: none"> <li>▪ Made of high-strength, low-alloy steel.</li> <li>▪ LinQ mount for easy-on, easy-off installation.</li> <li>▪ See table for installation location and requirements.</li> </ul>		
<b>LinQ Premium Storage Bag by OGIO</b>	Maverick, Maverick MAX	■ 715002923 · Black	2 233 zł
	<ul style="list-style-type: none"> <li>▪ Tool-less installation and removal thanks to the LinQ system.</li> <li>▪ 17.2 gal (65 L) capacity semi-rigid cargo bag ideal for carrying anything you need on your vehicle.</li> <li>▪ Buckle and elastic closure with a rubber seal that protects dust from entering the bag.</li> <li>▪ 3-section lid for partial or full access to your bag.</li> <li>▪ Inside separators for optimal bag organization.</li> <li>▪ See table for installation location and requirements.</li> </ul>		
<b>LinQ Low Profile Basket</b>	Maverick, Maverick MAX	715004282	1 064 zł
	<ul style="list-style-type: none"> <li>▪ Low profile, open basket increases cargo space.</li> <li>▪ Perfect for easy access to tools, rope, winch and plow accessories.</li> <li>▪ Multiple bungee cord and tie-down anchor points.</li> <li>▪ Made of impact-resistant injected polypropylene.</li> <li>▪ See table for installation location and requirements.</li> </ul>		
<b>LinQ Holders</b>			
<b>LinQ Tool Holder</b>	Maverick, Maverick MAX	715007358	282 zł
	<ul style="list-style-type: none"> <li>▪ Ultra-versatile tool holder.</li> <li>▪ Convenient swivel-latch allows tools to be stored in any orientation.</li> <li>▪ Sold in pairs.</li> </ul>		
<b>LinQ Gear Grips</b>	Maverick, Maverick MAX	715005340	628 zł
	<ul style="list-style-type: none"> <li>▪ Durable and flexible grips provide a custom fit for a variety of items from 1" to 4" (2.5 cm to 10 cm) in diameter.</li> <li>▪ Heavy-duty design for carrying bows, fishing poles, rakes, farm tools and more.</li> <li>▪ Quick-release button opens grip quickly for easy access to gear.</li> <li>▪ Heavy-duty base system built for the toughest adventures.</li> <li>▪ Make transporting your tools a snap by combining the LinQ Gear Grips with the LinQ System.</li> <li>▪ 360° orientation.</li> <li>▪ Sold in pairs.</li> </ul>		

## LinQ Mounting

<b>LinQ Anchor Adapter Kit</b>	Maverick, Maverick MAX	<b>715004960</b> <b>394 zł</b>
	<ul style="list-style-type: none"> <li>• Allows the installation of LinQ accessories with 16" base on LinQ racks.</li> <li>• Tool-less installation and removal.</li> </ul>	
<b>LinQ Base Installation Kit</b>	Maverick, Maverick MAX	<b>715008125</b> <b>155 zł</b>
	<ul style="list-style-type: none"> <li>• Allows installation of compatible LinQ accessories.</li> <li>• Included: 2 LinQ Cargo bases and hardware.</li> </ul>	
<b>Tube LinQ Adapter</b>	Maverick, Maverick MAX	<b>715004292</b> <b>179 zł</b>
	<ul style="list-style-type: none"> <li>• Cage mounted LinQ receiver.</li> <li>• Included in the LinQ Pivoting Rack assembly.</li> <li>• Allows the installation of single LinQ mounted accessory.</li> <li>• Diameter: 1.85" (47 mm).</li> </ul>	
<b>LinQ Lock</b>	Maverick, Maverick MAX	<b>860201968</b> <b>317 zł</b>
	<ul style="list-style-type: none"> <li>• Simple way to securely lock most LinQ accessories.</li> <li>• Lock cover protects lock from the elements.</li> <li>• Corrosion resistant.</li> <li>• Pack of 1, includes 2 keys.</li> <li>• Not compatible with LinQ 4.2 US gal (16 L) Cooler, LinQ Tool Box, LinQ Tool Holder or LinQ Gear Grips.</li> </ul>	
<b>LinQ Replacement Part</b>	Maverick, Maverick MAX	<b>715001707</b> <b>155 zł</b>
	<ul style="list-style-type: none"> <li>• Unique mounting fastener usable on any LinQ System accessory.</li> <li>• Tool-less installation and removal.</li> <li>• Sold in pairs.</li> </ul>	
<b>LinQ Adapter</b> <i>(Not illustrated)</i>	Maverick MAX	<b>715003058</b> <b>179 zł</b>
<ul style="list-style-type: none"> <li>• Allows the installation of the LinQ Tool Holder on the Adventure Roof Rack.</li> <li>• Sold in pack of 4.</li> </ul>		
<b>Cargo Box Net</b>	Maverick, Maverick MAX	<b>715001371</b> <b>341 zł</b>
	<ul style="list-style-type: none"> <li>• Solid net designed to secure and ensure the compact confinement of your Adventure Roof Rack.</li> </ul>	
<b>Spare Tire Ratchet Tie-Downs</b>	Maverick, Maverick MAX	<b>280000955</b> <b>183 zł</b>
	<ul style="list-style-type: none"> <li>• 3-way ratcheting tie-down strap with loop ends.</li> <li>• Designed to securely hold spare tires on accessories equipped with integrated spare tire attachment points.</li> <li>• Adjustable to accommodate most common UTV tire sizes.</li> <li>• Ratchet and junction ring made of durable zinc-plated steel.</li> <li>• Required for spare tire attachment on Adventure Roof Rack.</li> </ul>	



# RACKS & STORAGE

## Racks

### LinQ Pivoting Rack

Maverick (except X mr models), Maverick MAX

■ **715008295** - Black **3 254 zł**  
 ■ **715008296** - Can-Am Red **3 567 zł**



- LinQ latched rack allows for extra LinQ mounted accessories or for carrying a spare tire (tire not included).
- Includes custom tie-down strap for fast spare tire installation or removal (tire not included).
- Gas-cylinder pivot action, locks in the raised position.
- Trunk Boxes over 20 gal (74 L) do not fit on the vehicle when the rack is installed.
- Not compatible with Rear Intrusion Bars, Rear Cage Extension and Lonestar Racing Aluminum Roofs.

### Adventure Roof Rack

Maverick  
Maverick MAX

**715006225** **3 487 zł**  
**715003868** **3 807 zł**



- Ideal cargo solution for packing everything you need to live your Off-Road experience fully and completely.
- Built with lightweight 1.25" (3.2 cm) diameter steel tubing.
- Integrated mounting points for lights can hold up to eight pod-type LED lights (six front and two back) or a 40" (102 cm) LED bar (front).
- Features anchor points for spare-tire attachment.
- LinQ anchor on both sides.
- Spare Tire Tie-Downs sold separately.
- Add the Cargo Box Net to secure and confine your cargo in the rack.
- Loads up to 75 lb (34 kg).

## Storage

### Shoulder Storage Bag

Maverick (except X mr models),  
Maverick MAX (rear only)

**715004277** **597 zł**



- Bag attaches in unused space between the seats to increase your vehicle's cargo capacity.
- Installs between the rear seats only on MAX models.

### Front Shoulder Storage Bag

Maverick MAX

**715004888** **806 zł**



- Opens on each side so that both front and rear passengers can access the bag's content.
- Installs between the driver and passenger seats on MAX models.

### Overhead Storage Bag

Maverick, Maverick MAX

**715004275** **597 zł**



- Weather-resistant bag, holds your gear safely and securely while riding.
- Makes smart use of your overhead space to increase your vehicle's cargo capacity by 2.6 gal (10 L).
- Semi-rigid construction renders it flexible enough to fit odd-shaped loads.
- Touchscreen-compatible clear front pocket allows for easy access to your smartphone.
- Not compatible with the Bimini Roof.

### Upper Door Storage Bags

Maverick, Maverick MAX

**715004276** **751 zł**



- Weather-resistant, they'll hold your gear safely and securely while riding.
- Bags attach on stock quarter doors to increase your vehicle's cargo space.
- Each bag is designed as a 1.3 gal (5 L) capacity pocket also equipped with inner netting compartments.
- Semi-rigid construction renders them flexible enough to fit odd-shaped loads.
- Sold in pairs.

### Lower Door Panel Storage Bags

Maverick, Maverick MAX

**715004355** **960 zł**



- Weather-resistant, they'll hold your gear safely and securely while riding.
- Bags attach on Lower Door Panels to increase your vehicle's cargo space.
- Each bag is designed as a 1.6 gal (6 L) capacity pocket also equipped with inner netting compartments.
- Semi-rigid construction renders them flexible enough to fit odd-shaped loads.
- Sold in pairs.
- Not compatible with aluminum doors and Off-Road Screw Jack.
- Lower add-on doors required for installation.

**Soft Storage Bag**

Maverick, Maverick MAX

**715003759** **923 zł**



- 11.8 gal (45 L) capacity soft cargo bag designed with vehicle's rear in mind to maximize potential storage.
- 3 sections.
- Weatherproof.

**Storage 2.6 Gal (10 L) Bag**

Maverick, Maverick MAX

**269502121** **194 zł**



- Roll-top dry bag for fully protecting your cargo from the elements.

# LIGHTS

**2 Choose your lights**

1 Choose your mount point	BAJA DESIGNS <sup>†</sup> LIGHTS					CAN-AM LIGHTS				
	10" (25 cm) LED light bar	40" (102 cm) Baja Design OnX6 Arc LED Light Bar	XL Sport LED lights (sold in pairs)	Squadron Sport LED Lights (sold in pairs)	XL80 LED lights (sold in pairs)	10" double stacked LED bar	15" double stacked LED bar	39" double stacked LED bar	4" round LED lights (sold in pairs)	3.5" spot or flood LED lights (sold in pairs)
	Consult p. 109 information on Baja Designs lights.					Consult p. 110 for information on Can-Am lights.				
Front Pre-Runner or Dune Bumpers	710006819 + 715007049 (Power Cable)	710006818 + 715007117 (Power Cable)	710006821 + 715002884 (Power Cable)	710006820 + 715002884 (Power Cable)	710005041 + 715007049 (Power Cable)	715002933 + 715003417 (Power Cable)	715002934 (Not compatible with Pre-Runner Bumper) + 715003417 (Power Cable)		715002935 (4" Round), 715003665 (3.5" Flood) or 715003666 (3.5" Spot) + 715003417 (Power Cable)	
Lonestar Racing Front Bumper	NA	710006818 + 715007117 (Power Cable)	710006821 + 715002884 (Power Cable)	710006820 + 715002884 (Power Cable)	710005041 + 715007049 (Power Cable)				715002935 (4" Round), 715003665 (3.5" Flood) or 715003666 (3.5" Spot) + 715003417 (Power Cable)	
Light Support Bar or Adventure Roof Rack	710006819 + 715007049 (Power Cable)	710006818 + 715007117 (Power Cable)	710006821 + 715002884 (Power Cable)	710006820 + 715002884 (Power Cable)	710005041 + 715007049 (Power Cable)	715002933 + 715003417 (Power Cable)	715002934 + 715003417 (Power Cable)	710004007 + 715005822 (Light Mounting Kit)	715002935 (4" Round), 715003665 (3.5" Flood) or 715003666 (3.5" Spot) + 715003417 (Power Cable)	
Lonestar Racing 40" (102 cm) LED Light Bar Rack	NA	710006818 + 715007117 (Power Cable)	NA	NA	NA	NA	NA	NA	NA	NA
Lonestar Racing Light Rack	NA	NA	710006821 + 715002884 (Power Cable)	NA	710005041 + 715007049 (Power Cable)	NA	NA	NA	NA	NA

**3 Order**

**Order all part numbers in intersecting box**

*\*Note: When installing more than one light kit, additional light power cable or mounting kit is required.*

\*All lights are intended for off-road use only.

**Lights Power Cable**

(Not illustrated)

Maverick, Maverick MAX

**715003417** **268 zł**  
**715007049** **615 zł**  
**715002884** **400 zł**  
**715007117** **584 zł**

- Required for installation of Baja Designs LED lights onto roof or bumper.
- 10" (25 cm) Baja Designs OnX6 LED Bars and Baja Designs XL80 LED Lights (715007049).
- Baja Designs XL Sport LED Lights and Baja Designs Squadron Sport LED Lights (715002884).
- 40" (102 cm) Arc LED Light Bar ONX6 (715007117).

**40" (102 cm) Baja Designs OnX6 Arc LED Light Bar**

Maverick, Maverick MAX

710006818

10 767 zł



29,000 lumens

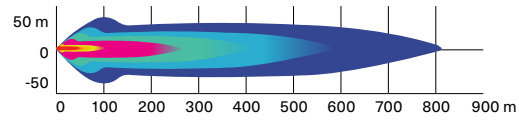

- 252 W light bar producing 29,000 lumens.
- Equipped with 24 Cree XM-L2 LEDs.
- Driving/Combo light pattern for smooth blend of light for both near field applications and distance.

- Designed for installation onto Light Support Bar equipped roofs.
- Requires Light Power Cable and Light Support Bar.

**Baja Designs 10" (25 cm) OnX6 LED Light Bar**

Maverick, Maverick MAX

710006819

2 841 zł



12,460 lumens

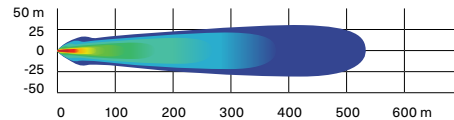

- 108 W light bar producing 12,460 lumens.
- Equipped with 6 Cree XM-L2 LEDs.
- Driving/Combo light pattern for smooth blend of light for both near field applications and distance.

- Dual intensity (high/low) settings.
- Requires Baja Designs Light Power Cable.

**Baja Designs XL80 LED Lights**

Maverick, Maverick MAX

710005041

5 352 zł



9,500 lumens

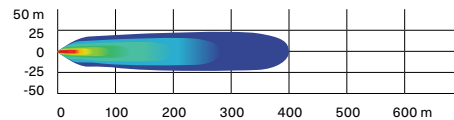

- 80 W per spot producing 9,500 lumens.
- Equipped with 4 Cree XHP50 LEDs per spot.
- Dual intensity (high/low) settings.
- Driving/Combo light pattern for smooth blend of light for both near field applications and distance.

- Require Baja Designs Light Power Cable.
- Sold in pairs.
- Dimensions: 4.5" x 4.5" (11.4 cm x 11.4 cm).

**Baja Designs Squadron Sport LED Lights**

Maverick, Maverick MAX

710006820

1 546 zł



3,150 lumens

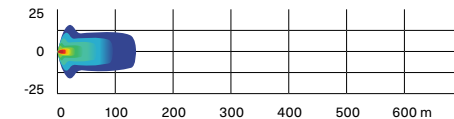

- 26 W per spot producing 3,150 lumens.
- Equipped with 4 Cree XP-G2 LEDs per spot.
- Wide cornering light pattern designed specifically for cornering, dust and/or fog conditions.

- Require Baja Designs Light Power Cable.
- Sold in pairs.
- Dimensions: 3" x 3" (7.6 cm x 7.6 cm).

**Baja Designs XL Sport LED Lights**

Maverick, Maverick MAX

710006821

2 665 zł



3,150 lumens

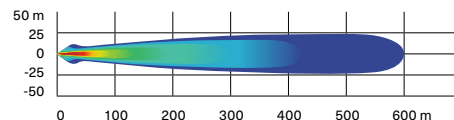

- 26 W per spot producing 3,150 lumens.
- Equipped with 4 Cree XP-G2 LEDs per spot.
- High Speed Spot features a longer and narrower beam focus for illumination farther down.

- Require Baja Designs Light Power Cable.
- Sold in pairs.
- Dimensions: 4.5" x 4.5" (11.4 cm x 11.4 cm).



**10" (25 cm) Double Stacked LED Light Bar (60 W)**

Maverick, Maverick MAX

715002933

1 754 zł



5,400 lumens

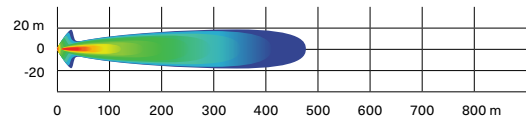

- Equipped with twelve 5 W Cree LEDs.
- 5,400 lumens.
- Packs a big punch for its size.
- Rugged and waterproof.

- Requires light power cable for installation.
- Lights up to more than 1,500 ft. (460 m) in front of the vehicle and around 65 ft. (20 m) wide on each side.
- Not EC compliant.

**15" (38 cm) Double Stacked LED Light Bar (90 W)**

Maverick, Maverick MAX

715002934

2 143 zł



8,400 lumens

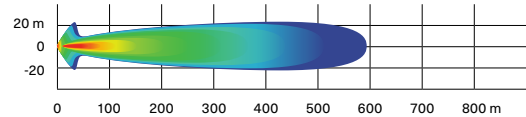

- Equipped with 18 5 W Cree LEDs.
- 8,400 lumens.
- Complements the Light Racks and most bumpers.

- Rugged and waterproof.
- Lights up to more than 1,900 ft. (580 m) in front of the vehicle and around 65 ft. (20 m) wide on each side.
- Not EC compliant.

**39" (99 cm) Double Stacked LED Light Bar (270 W)**

Maverick, Maverick MAX

715004007

4 206 zł



24,300 lumens

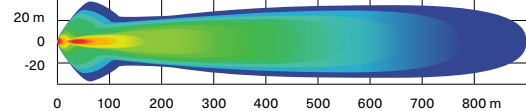

- Equipped with 54 5 W Cree LEDs.
- 24,300 lumens.
- Lights up to more than 2,900 ft. (900 m) in front of the vehicle and around 115 ft. (35 m) wide on each side.

- Compatible on the Adventure Roof Rack.
- Refer to light chart for installation requirements.

**4" (10 cm) Round LED Lights (2 x 25 W)**

Maverick, Maverick MAX

715002935

2 143 zł



1,800 lumens

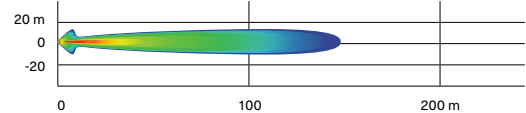

- 25 W LED spotlights.
- 1,800 lumens.

- Rugged and waterproof.
- Includes basic wiring and switch.

- Can-Am branded grill.
- Requires light power cable.

- Sold in pairs.
- Not EC compliant.

**3.5" (9 cm) LED Driving Lights (2 x 14 W)**

Maverick, Maverick MAX

715003666

1 215 zł



1,260 lumens

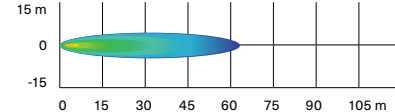

- 14 W LED lights producing 1,260 lumens each.
- Spot lens for a narrow and long light beam spread, ideal when driving at higher speeds.
- Equipped with six high-power LEDs in a heavy-duty die-cast aluminum housing.

- Features two attachment points. If one attachment point fails due to a collision, rotate to the next channel point and remount the light.
- Sold in pairs.
- CE certified.

**3.5" (9 cm) LED Flood Lights (2 x 14 W)**

Maverick, Maverick MAX

715003665

1 215 zł





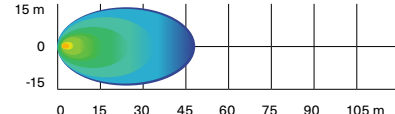

1,260 lumens











- 14 W LED lights producing 1,260 lumens each.
- Flood lens for a wide light beam spread, ideal for working applications like plowing or cornering. Suitable for dusty or foggy riding conditions.

- Equipped with six high-power LEDs in a heavy-duty die-cast aluminum housing.
- Features two attachment points. If one attachment point fails due to a collision, rotate to the next channel point and remount the light.
- Sold in pairs.
- CE certified.

<b>Can-Am LED Signature Lights</b>	Maverick, Maverick MAX	715003673 <b>1 130 zł</b>
	<ul style="list-style-type: none"> <li>• Add style with a more aggressive look.</li> <li>• Use bright and energy efficient LEDs.</li> <li>• Do not give additional lighting for driving.</li> </ul>	
<b>Dome Light</b>	Maverick, Maverick MAX	715002455 <b>474 zł</b>
	<ul style="list-style-type: none"> <li>• LED array integrates perfectly with vehicle.</li> <li>• Wiring included.</li> <li>• Can be installed on cage, Sport Roof or All-Terrain Trunk Cover.</li> </ul>	
<b>Lonestar Racing 40" (102 cm) LED Light Bar Rack</b>	Maverick, Maverick MAX	715003920 <b>1 913 zł</b>
	<ul style="list-style-type: none"> <li>• Designed for use with 40" (102 cm) Baja Designs OnX6 Arc LED Light Bar.</li> <li>• Enhances the vehicle's race-inspired look.</li> <li>• Compatible with Aluminum Roof, Lonestar Racing Aluminum Roof and Sport Roof.</li> <li>• Not compatible with Racing Side Mirrors and PowerFlip Windshield.</li> <li>• Lights sold separately.</li> </ul>	
<b>Lonestar Racing Light Rack</b>	Maverick, Maverick MAX	715003948 <b>1 913 zł</b>
	<ul style="list-style-type: none"> <li>• Designed for use with Baja Designs XL80 LED Light and Baja Designs XL Sport LED Light.</li> <li>• Accommodates up to two pairs of XL Lights.</li> <li>• Not compatible with Racing Side Mirrors and PowerFlip Windshield.</li> <li>• Compatible with Lonestar Racing Aluminum Roof, Aluminum Roof and Sport Roof.</li> <li>• Lights sold separately.</li> </ul>	
<b>Chase Lights</b>	Maverick, Maverick MAX	715002887 <b>4 108 zł</b>
	<ul style="list-style-type: none"> <li>• Designed by Can-Am to make you visible to vehicles riding behind you, especially in dusty or harsh conditions.</li> <li>• Feature in-dash switches to activate one of the two modes and to choose among 11 different high-visibility colored light patterns (blue, red and yellow).</li> <li>• Trail Mode: Serves as a tail light and as a brake light.</li> <li>• Race Mode: Displays light patterns and serves as a brake light (brake light function can be deactivated for racing applications).</li> <li>• Modular to allow installation with rear roll cage mounted accessories.</li> <li>• Plug-and-play installation.</li> </ul>	
<b>Light Support Bar</b>	Maverick, Maverick MAX	715003529 <b>1 304 zł</b>
	<ul style="list-style-type: none"> <li>• Sleekly styled rugged aluminum construction.</li> <li>• Accommodates light bars and spotlights with or without any roof and windshield combination.</li> <li>• Full vehicle width to allow the installation of any large LED light bar.</li> <li>• Required for light installation on vehicle's roof.</li> <li>• Not compatible with Lonestar Racing Aluminum Roof.</li> <li>• Lights sold separately.</li> </ul>	
<b>Mounting Kit for 39" (99 cm) LED Light Bar</b>	Maverick, Maverick MAX	715005822 <b>689 zł</b>
<i>(Not illustrated)</i>	<ul style="list-style-type: none"> <li>• Required for installation of the 39" (99 cm) double stacked LED Light Bar.</li> <li>• Includes wiring and support bracket.</li> <li>• Light Support Bar required for installation.</li> </ul>	
<b>Light Power Cable</b>	Maverick, Maverick MAX	715003417 <b>268 zł</b>
<i>(Not illustrated)</i>	<ul style="list-style-type: none"> <li>• Required for installation of 10" (25 cm), 15" (38 cm) and Double Stacked LED Light Bars and 4" (10 cm) Round LED Lights.</li> <li>• For bumper and roof mounting locations.</li> </ul>	

# AUDIO & COMMUNICATION SYSTEMS

## Audio

<b>Can-Am Audio Roof</b>	Maverick	<b>715007130</b> <b>16 968 zł</b>
	<ul style="list-style-type: none"> <li>• Full roof with sleek built-in audio.</li> <li>• Fully sealed and waterproof.</li> <li>• Easy to install: one wire connects the roof to the vehicle's electronics.</li> <li>• Four 8" speakers, one 400 RMS and 800 peak watt amplifier, and one Head Unit supplied by Rockford Fosgate Audio.</li> </ul>	<ul style="list-style-type: none"> <li>• Multi-colored RGB LED accent lighting around each speaker.</li> <li>• 2.7" color display with Bluetooth and Pandora connectivity.</li> <li>• Flip Kit-compatible.</li> <li>• Not compatible with the Adventure Roof Rack if the Flip Kit is installed.</li> <li>• Not compatible with the Upper Soft Door Panels.</li> </ul>
<b>Can-Am Audio Roof</b>	Maverick MAX	<b>715006709</b> <b>22 196 zł</b>
	<ul style="list-style-type: none"> <li>• Full roof with built-in audio.</li> <li>• Fully sealed and waterproof.</li> <li>• Easy to install, one wire connects the roof to the vehicle's electric system.</li> <li>• Six 8" Speakers, one 400 RMS and 800 Peak watt amplifier, one Head unit calibrated by Rockford Fosgate Audio.</li> </ul>	<ul style="list-style-type: none"> <li>• Multi-colored RGB LED accent lighting around each speaker. 2.7"</li> <li>• Colour Display with Bluetooth and Pandora connectivity.</li> <li>• Not compatible with the Adventure Roof Rack if the Flip Kit is installed.</li> <li>• Not compatible with the Upper Soft Door Panels.</li> </ul>
<b>Can-Am Audio Roof Flip Kit</b>	Maverick, Maverick MAX	<b>715007131</b> <b>2 546 zł</b>
	<ul style="list-style-type: none"> <li>• Combines with Audio Roof 715007130 or 715006709 for Flip option.</li> <li>• Not compatible with the Racing Side Mirrors (715002898).</li> </ul>	
<b>MTX Central Speakers</b>	Maverick MAX	<b>715004748</b> <b>4 570 zł</b>
	<ul style="list-style-type: none"> <li>• Top mounted central speaker case holding two 6.5" (16.5 cm)/100W speakers.</li> <li>• Designed to be Can-Am-tough in the most demanding riding conditions.</li> </ul>	<ul style="list-style-type: none"> <li>• Perfect add-on to the Complete MTX Audio System for a 7-speaker system or as a stand-alone system by plugging the AUX input jack directly into your music device.</li> <li>• Not compatible with Lonestar roofs.</li> </ul>
<b>Complete MTX Audio system</b>	Maverick, Maverick MAX	<b>715002873</b> <b>8 186 zł</b>
	<ul style="list-style-type: none"> <li>• Bluetooth 5+ equipped 400 W RMS/800 W peak audio system by MTX.</li> <li>• Designed to be Can-Am-tough in the most demanding riding conditions.</li> </ul>	<ul style="list-style-type: none"> <li>• Includes front-dashboard and rear-roll-cage mounted stereo speakers and head unit with an integrated 6.5" (16.5 cm) subwoofer.</li> <li>• Add the Electronic Device Holder to securely hold your Bluetooth device ready to play your favorite tunes.</li> </ul>
<b>Can-Am Subwoofer</b>	Maverick, Maverick MAX	<b>715004956</b> <b>3 266 zł</b>
	<ul style="list-style-type: none"> <li>• Powerful Rockford Fosgate Underseat 10" Subwoofer speaker box.</li> <li>• Easy plug-and-play connections to Audio Roof system.</li> <li>• Sturdy construction tough enough to withstand harsh environments and sealed against moisture and dirt.</li> </ul>	<ul style="list-style-type: none"> <li>• Requires 1 Amplifier kit (715007227) for 1 or 2 subwoofers.</li> <li>• Fits two per vehicle: under driver or passenger seat.</li> <li>• Wiring included.</li> </ul>
<b>Can-Am Amplifier kit</b>	Maverick, Maverick MAX	<b>715007227</b> <b>3 266 zł</b>
	<ul style="list-style-type: none"> <li>• A powerful 400 W amplifier to feed up to two Underseat Subwoofers.</li> <li>• Easy plug-and-play connections to Audio Roof system and subwoofer.</li> <li>• Installation plate and wiring included.</li> </ul>	
<b>Electronic Device Holder</b>	Maverick, Maverick MAX	<b>715002874</b> <b>861 zł</b>
	<ul style="list-style-type: none"> <li>• A great in-ride entertainment system platform.</li> <li>• Robust injected-polypropylene construction allows for right fit and easy installation.</li> <li>• Adjustable unit safely holds most tablets and smartphones measuring between 5.1" (13 cm) and 10" (25.4 cm) (with protective case).</li> </ul>	<ul style="list-style-type: none"> <li>• Combines seamlessly with Complete MTX Audio System and Rugged Radios Intercom System.</li> <li>• Allows the installation of Garmin Montana 680T GPS.</li> <li>• Integrated storage (1 gal [3.8 L] capacity) with access to the dash 12V outlet for device charging.</li> </ul>



## Communication Systems

### Rugged Radios Car-to-Car System

Maverick, Maverick MAX

715003440 · US ONLY



- Perfect for communicating with friends and family on group rides.
- Push-to-talk button conveniently mounted on the steering wheel.
- May be connected with the Rugged Radios Intercom System (with provided adapter cable).
- This kit includes:
  - 5-watt V3 radio: UHF/VHF + FM frequency, programmable channels, 5 watts of power, includes belt clip, recharging cable, high capacity, all day lithium-ion battery, 1-3 mile range, NOAA weather channels, 1-touch FM radio, backlit screen/buttons
  - Helmet speaker/mic kit: Clear Hear audio speakers, Full Flex mic boom, cloth mic cover, Velcro mount speakers, quick & easy install
  - Harness & cables: single person harness, driver coil cord PTT, waterproof PTT, radio mounting bracket, complete plug & play kit

### Rugged Radios Intercom System

Maverick, Maverick MAX

715002891 · US ONLY



- Specifically designed to facilitate clear in-vehicle communication between driver and passenger(s).
- Expandable to 4 people.
- Includes music port for enjoying your favorite tunes.
- Seamless integration with in-dash switch panel.
- May be synched with the Rugged Radios Car-to-Car System (715003440). Accessory not available in Canada.
- Power Cable is required for installation on MAX models.

### Rugged Radios Helmet Headset Kit for Rear Passengers

With Rugged Radios Intercom System

715004380 · US ONLY



- Additional 12' (3.7 m) cables and Helmet Speaker/Mic Kits to upgrade your 2-person intercom system to a 4-person system.
- Power Cable is required for installation on MAX models.

# ELECTRICAL & ELECTRONIC ACCESSORIES

## Electrical

### Seat Heater

Maverick, Maverick MAX

715006112 726 zł



- 25 W seat heater delivers chill-free riding comfort.
- High/low temperature settings allow you to control the desired degree of warmth.
- This kit includes one carbon fiber seat heater, foam sheet and in-dash switch.
- Installs directly in the original seat cushion.
- Heated Accessories Wiring Harness (710005757) is required for front seat installation.
- Heated Accessories Wiring Harness (715006004) is required for rear seat installation.

### Heated Visor Outlet

Maverick, Maverick MAX

715001246 317 zł



- Strategically positioned on vehicle to maintain your agility.
- Optional visor outlet that delivers fog-free riding.
- Quick and easy installation.
- Sold individually.
- Heated Visor not included.

### Heated Accessories Wiring Harness

(Not illustrated)

Maverick, Maverick MAX

710005757 609 zł

- Electric harness required to hook up and operate front heated seats, heated steering wheel and heated grab bar.
- Heated Accessories Wiring Harness (715006004) is required for rear seat installation.

### Auxiliary Battery Installation Kit







(Not illustrated)

Maverick, Maverick MAX

715006315 1 532 zł

- Allows you to add a second 18Ah battery for a dual battery setup necessary to power auxiliary electrical components such as sound systems or winches.
- Equipped with an IP67-rated waterproof electronic module that will prevent your auxiliary electrical components from draining your starting battery.
- Kit includes an additional battery junction block, all necessary wiring and the battery holder.
- Both batteries are perfectly integrated, in stock location, behind the passenger seat.
- Additional battery (410301203), plus battery hardware (250000282) sold separately.

## Electronic Accessories

<b>USB Power Outlet Kit</b>	Maverick, Maverick MAX	<b>219400510</b> <b>206 zł</b>
	<ul style="list-style-type: none"> <li>Recharges your electronic devices while riding* (smartphone, MP3, heating gear, etc.).</li> <li>Dual port USB connectors.</li> </ul> <p><i>*The power outlet is not capable of recharging all device types while riding.</i></p>	
<b>Lighted Whip Flag</b>	Maverick, Maverick MAX	<b>715002886</b> <b>1 722 zł</b>
	<ul style="list-style-type: none"> <li>A must for riding the dunes.</li> <li>5 W Cree LED.</li> <li>5 colored lenses to allow personalization.</li> <li>Glow-through whip, quickly removable and replaceable pole.</li> <li>Increases vehicle's visibility.</li> </ul> <ul style="list-style-type: none"> <li>Meets most dune-area requirements.</li> <li>Die cast aluminum base, acetal hand nut.</li> <li>Includes mounting brackets and wiring.</li> <li>4' (1.2 m) flag mounts on top of the roll cage.</li> <li>Can be installed on both sides of a vehicle.</li> </ul>	
<b>Battery Charger/Maintainer</b>	<b>715005061</b>	
	<ul style="list-style-type: none"> <li>Keeps stored lead-acid batteries charged.</li> <li>Charges and maintains small batteries.</li> <li>Microprocessor controlled multi-stage charging for added precision, safety and battery life.</li> <li>Automatically detects 6 or 12 volt batteries.</li> <li>Reverse hook-up protection helps protect battery and charger from damage.</li> </ul> <ul style="list-style-type: none"> <li>Auto-voltage detection.</li> <li>Press the display button to show the charge progress.</li> <li>Content: 3 amp battery charger, clamp adapter, DC adapter, 24" (61 cm) fused ring leads harness with weather cap, owner's manual.</li> <li>Not EC compliant.</li> <li>US plug (110V).</li> <li>Not available in Europe.</li> </ul>	
<b>Jump Starter</b>	<b>715005062</b>	
	<ul style="list-style-type: none"> <li>IPX3 water-resistant and enclosed output ports.</li> <li>4 LED battery indicators for easy read on battery charge level.</li> <li>Compact design, will conveniently fit in your backpack, glove box or any other storage compartment.</li> <li>2.4A + 1A/5V USB ports for fast charging of all USB devices.</li> </ul> <ul style="list-style-type: none"> <li>Smart cable provides protection against reverse polarity, short circuit, low voltage, high temperature and reverse charging.</li> <li>Built-in LED light (3 modes).</li> <li>Content: 300CA jump starter, SA858 smart cable clamp, MC-USB to USB charging cable, travel bag, user manual.</li> <li>Not EC compliant.</li> <li>Not available in Europe.</li> </ul>	
<b>Quick Connect Battery Cable</b>	<b>715005408</b> <b>45 zł</b>	
	<ul style="list-style-type: none"> <li>Quickly and easily connect and charge different batteries with your charger.</li> <li>Included in the Battery Charger/Maintainer.</li> <li>Sold individually.</li> <li>Not available in Europe.</li> </ul>	
<b>Quick Connect Cable with Battery Indicator</b>	<b>715006055</b> <b>115 zł</b>	
	<ul style="list-style-type: none"> <li>Quickly and easily connect and charge different batteries with your charger.</li> <li>3-color LED indicator provides constant battery health indication.</li> <li>Sold individually.</li> <li>Not available in Europe.</li> </ul>	
<b>Digitally Encoded Security System (D.E.S.S.) Green Key</b>	Maverick (Turbo/TurboR/Turbo RR motorization)	<b>710005232</b> <b>289 zł</b>
	<ul style="list-style-type: none"> <li>Top-security anti-theft protection for your vehicle.</li> <li>Encrypted chip technology restricts access to your vehicle's electronic ignition system.</li> <li>One vehicle/one code.</li> <li>A vibration/shock-resistant ball-and-socket design that ensures a reliable connection.</li> </ul> <ul style="list-style-type: none"> <li>3 programmable modes: <ul style="list-style-type: none"> <li>Work mode: Limits vehicle speed to 40 kph (25 mph) but does not limit engine torque.</li> <li>Normal mode: Limits vehicle speed to 70 kph (44 mph) and 50% torque reduction.</li> <li>Performance mode: No restrictions.</li> </ul> </li> </ul>	

# WINCHES & HITCHES

## Can-Am HD Winches

### Can-Am HD 4500 Winch

Maverick, Maverick MAX

715006416

1 788 zł



- Ergonomic clutch handle.
- Rugged all-steel gears and bushings for more torque and durability.
- Automatic 100% load-holding brake.
- Sealed solenoid for all-weather protection.
- Weather sealed corded remote and dash mounted switch.
- EC compliant.
- Pulling strength capability of 4,500 lb (2,041 kg).
- 43' of 1/8" (13.1 m of 6.3 mm) wire steel cable.
- Heavy-duty 4-way roller fairlead.
- Winch Electrical Harness (715003585) and winch compatible front bumper are required.

### Can-Am HD 4500-S Winch

Maverick, Maverick MAX

715006417

2 391 zł



- Ergonomic clutch handle.
- Rugged all-steel gears and bushings for more torque and durability.
- Automatic 100% load-holding brake.
- Sealed solenoid for all-weather protection.
- Weather-sealed corded remote and dash mounted switch.
- Pulling strength capability of 4,500 lb (2,041 kg).
- 50' of 1/4" (15.2 m of 6.35 mm) synthetic rope.
- Corrosion-proof aluminum hawse fairlead.
- Winch Electrical Harness (715003585) and winch compatible front bumper are required.

## WARN<sup>+</sup> VRX Winches

### WARN VRX 45 Winch

Maverick, Maverick MAX

715006110

3 045 zł



- Extreme IP68-rated waterproof sealing keeps the elements out.
- Durable all-metal construction.
- Black powder-coated finish and stainless steel fasteners for corrosion resistance.
- Robust new clutch design based on 70+ years of WARN 4 WD hub lock know-how.
- Load-holding brake for great control.
- Smooth and reliable all-metal three-stage planetary gear train.
- Dash-mounted rocker control.
- Limited lifetime warranty (mechanical), 3-year warranty (electrical).
- Pulling strength capability of 4,500 lb (2,041 kg).
- 50' of 1/4" (15 m of 6.3 mm) wire steel cable.
- Roller fairlead.
- Winch Electrical Harness (715003585) and winch compatible front bumper are required.

### WARN VRX 45-S Winch

Maverick, Maverick MAX

715006111

3 631 zł



- Extreme IP68-rated waterproof sealing keeps the elements out.
- Durable all-metal construction.
- Black powder-coated finish and stainless steel fasteners for corrosion resistance.
- Robust new clutch design based on 70+ years of WARN 4 WD hub lock know-how.
- Load-holding brake for great control.
- Smooth and reliable all-metal three-stage planetary gear train.
- Dash-mounted rocker control.
- Limited lifetime warranty (mechanical), 3-year warranty (electrical).
- Pulling strength capability of 4,500 lb (2,041 kg).
- 50' of 1/4" (15 m of 6.3 mm) synthetic rope.
- Cast aluminum hawse fairlead.
- Winch Electrical Harness (715003585) and winch compatible front bumper are required.

## Winch Accessories

### Can-Am HD Hawse Fairlead

Can-Am HD Winch

715006426

274 zł



- A must when upgrading your winch with a synthetic cable, this corrosion-proof aluminum hawse fairlead will prevent the cable from snapping in a corner of a roller fairlead and from wearing prematurely due to the rough surface of the worn roller guide.
- Must be used with synthetic cables only.

### WARN Hawse Fairlead

WARN Winch

715007785

603 zł



- Double-powder-coated construction.
- Required to use the Synthetic Winch Cable (715001118) on WARN winches.
- To be used with synthetic winch cables only.

### Synthetic Winch Cable

Can-Am HD Winch

715006430

720 zł

WARN Winch

715007783

831 zł



- 50' of 1/4" (15.2 m of 6.35 mm) synthetic cable for Can-Am HD winches.
- Can-Am HD Hawse Fairlead (715006426) is required when upgrading to a synthetic cable to avoid premature cable damage and wear.
- WARN Hawse Fairlead (715007785) is required when upgrading to a synthetic cable to avoid damage and premature wear of the cable.



<b>Wire Rope Replacement</b>	Can-Am HD Winch	<b>705014978</b>	<b>107 zł</b>
	WARN Winch	<b>715006699</b>	<b>449 zł</b>



- 43' of 1/4" (11.3 m of 6.3 mm) wire rope for Can-Am HD Winch.
- 55' of 1/4" (16.8 m of 6.35 mm) wire rope for WARN winch kit.
- 4,500 lb (2,041 kg) pulling strength.

<b>Synthetic Cable Extension</b>		<b>715001120</b>	<b>947 zł</b>
----------------------------------	--	------------------	---------------



- Lightweight 1/4" (6.35 mm) diameter, easy to handle and won't rattle in cargo box.
- Easily attaches to winch cable to provide additional 50' (15.2 m) of distance.
- 4,500 lb (2,041 kg) single line capacity.

<b>Winch Electrical Harness</b> <i>(Not illustrated)</i>	Maverick, Maverick MAX	<b>715003585</b>	<b>615 zł</b>
---	------------------------	------------------	---------------

- Required for winch installation.

<b>Rear Winch Harness</b> <i>(Not illustrated)</i>		<b>715006007</b>	<b>1 218 zł</b>
---	--	------------------	-----------------

- Required for installation of a winch on the S3 Rear Winch Bumper.

<b>Wired Remote Control</b>	Can-Am HD Winch*	<b>715006504</b>	<b>119 zł</b>
-----------------------------	------------------	------------------	---------------



- This kit allows winch owners to add the hand-held remote to vehicles with a stock winch.
- OEM stock winch is sold separately.
- EC compliant.

† Harness (710001023) is required to use remote control on a vehicle with a factory installed winch.  
‡ Remote control (710007050) and connection socket are included.

<b>Wireless Remote Control</b>	WARN Winch	<b>715002542</b>	<b>1 080 zł</b>
--------------------------------	------------	------------------	-----------------



- The system is quick and easy to install, thanks to a wiring harness with an integrated antenna and all necessary mounting hardware.
- The system allows you to operate your winch from anywhere within a 50' (15.2 m) radius, increasing your recovery options.
- All components are weatherproof.

<b>X rc/X mr Rear Tow Hook</b>	Maverick, Maverick MAX 2021 & prior	<b>715004450</b>	<b>418 zł</b>
--------------------------------	-------------------------------------	------------------	---------------



- Offers a solid place to hook onto in case towing is needed.
- Allows you to attach most straps and hooks.
- Made of rugged 3/16" (5 mm) steel plate and 5/8" (16 mm) steel hook tube.
- Standard on Maverick X rc and X mr models.

## Hitches

<b>Rear Hitch</b>	Maverick, Maverick MAX 2021 & prior	■ <b>715002883</b> · Black	<b>744 zł</b>
		■ <b>715003938</b> · Can-Am Red	<b>947 zł</b>



- Rugged lightweight steel construction.
- E-coated finish.
- Fixed mounting point for trailer ball to provide vehicle with towing capabilities.
- This hitch offers 1,300 lb (590 kg) of towing capacity.
- Hitch ball not included.

<b>Front and Rear Hitch Drawbar</b>	Maverick, Maverick MAX	<b>715008350</b>	<b>486 zł</b>
-------------------------------------	------------------------	------------------	---------------



- Standard on 2" (5 cm) receiver hitch.
- It offers 1,650 lb (750 kg) of towing capacity.
- Hitch ball not included.
- Forged steel.

# PERFORMANCE

## Smart-Lok Technology

### Smart-Lok Differential

Maverick produced after January 1, 2017  
Maverick MAX

**705402936 8 426 zł**



- Can-Am-exclusive Smart-Lok technology constitutes a true fully lockable on-the-fly front differential with electronically controlled automatic modes.
- Choose your differential settings according to your riding need: "2x4" for rear wheel traction only, "4x4 Front Diff Lock" for a fully locked 4 wheel drive, and "4x4 Smart Mode" that offers preset, intelligent calibrations for your type of riding.
- Using multiple input sources, "Smart Mode" will instantaneously engage locking with the right load at the right moment to procure maximum traction while retaining low-speed maneuverability, allowing for optimal placement and a feeling of confidence.
- The Smart-Lok Differential Kit comes standard with the Trail Mode.
- Mud, Rock and Trail Activ modes can be added by installing an additional Smart Mode Module (sold separately) to fine-tune your riding environment.
- Requires Performance Half Shafts (2x) and Smart-Lok Installation Kit for installation.

### Performance Half Shaft

Maverick, Maverick MAX  
Maverick, Maverick MAX

**705401634 · 64" 1 230 zł**  
**705402048 · 72" 1 230 zł**



- High-performance design ideal for off-road use, with superior protection in any riding usage.
- Includes CVs, shaft and boots with the best suited geometry for your Can-Am vehicle.
- Required to install the Smart-Lok Differential Kit.

### Mud Smart Mode Module

*(Not illustrated)*

Maverick, Maverick MAX with Smart-Lok Differential  
(except Turbo RR models 2021 & up)

**715005282 917 zł**

- This module allows you to add the Mud Smart Mode to vehicles with the Smart-Lok Differential Kit sold as an accessory or to change to the Mud Smart Mode on vehicles equipped with a standard Smart-Lok.
- The Mud Mode has been specially designed to deliver superior traction in the deepest mud holes.
- When high engine torque and/or slippage is detected, Smart-Lok will fully lock the front end.
- The system will stay locked until throttle release.
- Only one Smart Mode Module can be installed at a time.

### Rock Smart Mode Module

*(Not illustrated)*

Maverick, Maverick MAX with Smart-Lok Differential  
(except Turbo RR models 2021 & up)

**715005283 917 zł**

- This module allows you to add the Rock Smart Mode to vehicles with the Smart-Lok Differential Kit sold as an accessory or to change to the Rock Smart Mode on vehicles equipped with a standard Smart-Lok.
- The Rock Mode has been specially designed to help cross challenging rocks.
- When high engine torque is detected at low vehicle speed, Smart-Lok will progressively lock the front end and will stay engaged until throttle release to prevent wheel slippage and provide optimal traction.
- The progressive engagement allows for easier steering when maneuvering the vehicle.
- Only one Smart Mode Module can be installed at a time.

### Trail Activ Smart Mode Module

*(Not illustrated)*

Maverick, Maverick MAX with Smart-Lok Differential  
(except Turbo RR models 2021 & up)

**715005284 917 zł**

- This module allows you to add the Trail Activ Smart Mode to vehicles with the Smart-Lok Differential Kit sold as an accessory or to change to the Trail Activ Smart Mode on vehicles equipped with a standard Smart-Lok.
- The Trail Activ mode has been designed for aggressive riding, delivering the ultimate cornering precision.
- When high engine torque and/or an increase in vehicle speed is detected, Smart-Lok will progressively engage the front end and maintain it engaged until throttle release or vehicle speed reduction.
- The progressive engagement allows for smoother and lower steering effort.
- Only one Smart Mode Module can be installed at a time.







### Lonestar Racing Mud Flaps with Brackets

Maverick, Maverick MAX

**715004865 1 575 zł**



- These bolt-on mud flaps make a great addition.
- Durable chromoly brackets.
- Protect trailing arms, rotors and CVs from rocks and debris.
- Sold in pairs.

<b>Lonestar Racing Heavy-Duty Shift Plate &amp; Knob</b>	Maverick, Maverick MAX	715004866 <b>824 zł</b>
	<ul style="list-style-type: none"> <li>• The shift plate is made from durable stainless steel and bolts into place for a secure fit.</li> <li>• The kit comes with a billet aluminum Lonestar Racing shift knob.</li> <li>• Offers improved durability for the performance-oriented driver.</li> </ul>	
<b>Lonestar Racing Outer Toe Link Boxed Gussets Roller Fairlead</b>	Maverick, Maverick MAX 2021 & prior	715004868 <b>763 zł</b>
	<ul style="list-style-type: none"> <li>• Protects and strengthens the middle radius rod links from rough riding conditions.</li> <li>• Includes high-grade steel bolts.</li> </ul>	
<b>Lonestar Racing Quick Release Clutch Cover Pins</b>	Maverick, Maverick MAX	715005045 <b>591 zł</b>
	<ul style="list-style-type: none"> <li>• This kit will allow you to take off your clutch cover in seconds to access the belt tool-lessly.</li> <li>• Includes 4 stainless steel "quick release" pins with clips and tethers.</li> <li>• Replaces all clutch cover screws.</li> <li>• This product affects the clutch cover sealing. It is highly recommended to use this product under dry riding conditions only.</li> </ul>	
<b>Lonestar Racing Heavy-Duty Rear Boxed Radius Rod Support Plate</b>	Maverick, Maverick MAX 2021 & prior	715005046 <b>1 243 zł</b>
	<ul style="list-style-type: none"> <li>• Double-layered radius rod support plate made of high-grade steel.</li> <li>• Reinforces your rod mounting location on the frame while adding a mean racing look to your vehicle.</li> <li>• Easy to install.</li> </ul>	
<b>X rc Brake Pedal</b>	Maverick, Maverick MAX	715004901 <b>305 zł</b>
	<ul style="list-style-type: none"> <li>• Brake pedal with larger foot surface.</li> <li>• This improves ergonomics and control for the rider in rock climbing conditions.</li> </ul>	
<b>Yoshimura<sup>†</sup> Slip-on Exhaust</b>	Maverick, Maverick MAX	715002882 <b>9 625 zł</b>
	<ul style="list-style-type: none"> <li>• Developed in collaboration with Yoshimura.</li> <li>• Made from 304-grade stainless steel with brushed aluminum tip.</li> <li>• Better sounding, better looking and 19% lighter than stock muffler.</li> <li>• USDF/USDA approved spark arrester.</li> <li>• Fuel injection system tuning not required.</li> <li>• ROHVA and EPA compliant.</li> <li>• Not EC compliant.</li> </ul>	
<b>Performance Air Filter by Twin AIR<sup>†</sup></b>	Maverick, Maverick MAX	715002895 <b>529 zł</b>
	<ul style="list-style-type: none"> <li>• The best choice for the harshest conditions.</li> <li>• Multiple staged oiled filtering foam for superior dust retaining capacity with high airflow.</li> <li>• Washable and reusable.</li> </ul>	
<b>Foam Replacement</b> <i>(Not illustrated)</i>	Maverick, Maverick MAX	715000713 <b>1 169 zł</b>
<ul style="list-style-type: none"> <li>• Replacement foam for Performance Twin Air Filter.</li> </ul>		



<b>Snorkel Pre-filter</b>	Maverick, Maverick MAX (with Snorkel Kit)	<b>715005599</b>	<b>591 zł</b>
---------------------------	---	------------------	---------------



- Pre-filter specifically for snorkels.
- Adds extra protection to your engine in harsh riding conditions.
- Helps keep air filter cleaner.
- Filter blocks particles larger than 0.005" (0.13 mm).
- Necessary to maintain vehicle warranty when tracks are installed.

<b>Snorkel Kit</b>	Maverick, Maverick MAX (2019 and prior)	<b>715003733</b>	<b>4 281 zł</b>
	Maverick, Maverick MAX (2020 & up)	<b>715007110</b>	<b>4 490 zł</b>



- Raises point of engine and CVT air intakes so vehicle can be semi-submersed in water or mud without the engine taking in water.
- Not compatible with S&B Particle Separator, LinQ Pivoting Rack, Lonestar Racing Rear Intrusion Bar or any rear panels or windows.
- Sealed Air Box 707800780 (sold separately) is required for installation on models manufactured before January 1, 2018.
- Standard on Maverick X mr models.
- Not EC-compliant.

<b>Radiator Relocator</b>	Maverick, Maverick MAX	<b>715004937</b>	<b>7 405 zł</b>
---------------------------	------------------------	------------------	-----------------



- Relocates stock radiator to rear of cage.
- Protects it from debris and rocks.
- Prevents cooling performance loss in muddy conditions.
- Reduces hot air in the cabin.
- Easy to clean.
- Includes support hardware and hoses.
- Not compatible with any bed accessories, Rear Cage mounted accessories, Complete MTX Audio system and Upper Soft Doors (except LinQ 8 gal [30 L] Cooler Box).
- Radiator (709200703) is required for installation on 2017 models.
- Not compatible with full windshield.

WARNING: Any modifications or addition of accessories may affect the handling of your vehicle. It is important to take the time to get familiar with the vehicle once modifications are made to understand how to adapt your driving behavior accordingly. Do not tamper with unauthorized modifications or install equipment not specifically certified by BRP for the vehicle. These modifications have not been tested by BRP and they may increase the risk of injury or loss of control, or render the vehicle illegal to ride. Ask your authorized BRP dealer for suitable available accessories for your vehicle.

<b>Arched Lower Suspension Links</b>	Maverick, Maverick MAX	<b>715005065</b> · 64" models	<b>1 175 zł</b>
		<b>715005066</b> · 72" models	<b>1 243 zł</b>



- Arched lower links to free up more ground clearance.
- Standard on X mr and 2022 X rc models only.

<b>850 W Magneto Kit</b>	Maverick, Maverick MAX (2021 & up)	<b>715006279</b>	<b>3 844 zł</b>
--------------------------	------------------------------------	------------------	-----------------



- Increases the magneto output to 850 W.
- Includes rotor, stator and regulator.

<b>High Output 172 HP Upgrade Kit X3</b>	Maverick, Maverick MAX (2017 models)	<b>715004700</b>	<b>8 389 zł</b>
--	--------------------------------------	------------------	-----------------



- Performance upgrade kit for Maverick 2017 models only.
- Gain 18 HP for a total of 172 HP.
- Includes: intercooler with fan, fuel pump catalyst and high performance belt.
- Installation must be done by an authorized BRP dealership to preserve the vehicle's warranty.
- C.A.R.B. Executive Order #D-799U.

<b>172 HP Intercooler Upgrade Kit</b> <i>(Not illustrated)</i>	Maverick, Maverick MAX (2018 and 2019)	<b>715007137</b>	<b>4 644zł</b>
	Maverick, Maverick MAX (2020)	<b>715007277</b>	<b>4 644 zł</b>

- Intercooler upgrade for the Maverick 2018 & up.
- Installation must be done by an authorized BRP dealership to preserve the vehicle's warranty.
- Requires the power upgrade installation kit (715007111).

<b>Power Upgrade Installation Kit</b> <i>(Not illustrated)</i>	Maverick, Maverick MAX (2018-2020)	<b>715007111</b>	<b>4 723 zł</b>
---	------------------------------------	------------------	-----------------

- Increases the power of the Maverick from 120 HP to 172 HP.
- Includes fuel pump, clutch components and turbo adjustment.
- Installation must be done by an authorized BRP dealership to preserve the vehicle's warranty.
- Requires Maverick intercooler specific to model year (715007137 or 715007277).

WARNING: Any modifications or addition of accessories may affect the handling of your vehicle. It is important to take the time to get familiar with the vehicle once modifications are made to understand how to adapt your driving behavior accordingly. Do not tamper with unauthorized modifications or install equipment not specifically certified by BRP for the vehicle. These modifications have not been tested by BRP and they may increase the risk of injury or loss of control, or render the vehicle illegal to ride. Ask your authorized BRP dealer for suitable available accessories for your vehicle.

## Emergency Accessories

### Lonestar Racing Fire Extinguisher Support

Maverick, Maverick MAX

715003734 1 095 zł



- Quick-release support that allows you to slide the fire extinguisher out in a matter of seconds in an emergency situation.
- Made of billet anodized black aluminum.
- Provides you with the safety and security of having dependable emergency equipment on board.
- Fits 1.85" (4.7 cm) tubing.
- Can be fixed everywhere on the cage.
- Comes with both billet mounts, quick-pull pin, mounting plate and 2 clamps.
- Fire extinguisher sold separately.
- "Lonestar Racing for Can-Am" branded.

### Fire Extinguisher

295100833 175 zł



- Ideal for grease, oil and electrical fires.
- Fits with Lonestar Racing Fire Extinguisher Support Kit.
- Not EC compliant.

### Emergency Kit

Maverick, Maverick MAX

715006102 763 zł



- Complete emergency kit provides all essential equipment and supplies to get out of most unfavorable situations powersport enthusiasts can find themselves in.
- Includes: jumper cables, air compressor, tire repair kit, ratchet tie-down, duct tape, 3,300 lb (1,500 kg) tow strap, zip-ties, cloth rags

# TRAILERING

### Trailer Cover

(Not illustrated)

Maverick

715005813 2 097 zł

Maverick MAX

715005814 2 639 zł

- Heavy-duty canvas made of UV-resistant solution-dyed polyester.
- Inner soft liner protects windshield and colored panels from abrasion.
- All high-abrasion areas are reinforced with a double canvas layer.
- Weather-resistant trailering cover protects your vehicle during storage and transportation.
- Opening for fuel cap and cabin access on passenger side.
- Quick and easy installation.
- Designed to perfectly fit your vehicle with or without Can-Am accessories.

### Bolt-On<sup>+</sup> Retractable Ratcheting Tie-Downs

295101072 186 zł



- Perfect for transporting your powersport vehicle or securing loads.
- Mounts easily: bolts on any flat surface (e.g., truck bed or frame).
- 1" x 6' (2.5 cm x 1.8 m) tie-down strap with heavy-duty stitching that delivers a 500 lb (226 kg) working load strength and 1,500 lb (680 kg) break strength.
- Convenient retractable push button automatically slackens, spools and stores away strap, while the ratchet mechanism tightens the strap snugly to secure your vehicle or load into place.
- Rubber ratcheting handle provides firm grip, and the hook is vinyl coated to protect whatever surface it hooks into.
- Sold in pairs.

### Ratchet Tie-Downs

715008309 · Black/Gray 107 zł



- 400 lb (181 kg) safe working load.
- 1" x 10' (2.5 cm x 3 m) strap with Sea-Doo, Ski-Doo and Can-Am logos.
- Deluxe ratchet with rubber handle.
- Coated S hooks.
- Pack of 2.

### Heavy-Duty Ratchet Tie-Down

715008308 230 zł



- 1,000 lb (454 kg) safe working load.
- 1.5 in. x 6 in. (38 mm x 1.8 mm) strap with BRP brands.
- Deluxe ratchet with rubber handle.
- Black-coated clip hooks.
- 12" (300 mm) webbing included.
- Pack of two.

# APACHE TRACK SYSTEMS

## Winter Tracks

## Limited Warranty\*

### Apache Backcountry LT Track System

Maverick, Maverick MAX

715004734 **45 678 zł**



- Tracks designed to deliver the best snow performance on the market with unmatched flotation level and traction on snow surface.
- Large contact patch, 37% bigger than the Apache 360 LT.
- Impressive added ground clearance of 7" (18 cm) helps keep the vehicle over the snow.
- Lightweight snowmobile-inspired rail design.
- Aggressive track design with 2" (5 cm) lug height for maximum traction on snow.
- Apache Backcountry LT Mounting Kit, Track DPS Module and Engine and CVT Pre-Filter are required.
- Fine-tune your track system using extra Idler Wheels, Sliders with Vespel Inserts and Rail Ice Scratcher.
- For winter use only.
- Track installation will affect vehicle width and length.

### Apache Backcountry LT Mounting Kit

(Not illustrated)

Maverick, Maverick MAX

715004397 · 64" models **4 712 zł**  
715004394 · 72" models **5 341 zł**

- Required for installation of the Apache Backcountry Track LT System.
- DPS module and Pre-Filter are required and sold separately.

## Year-Round Tracks

## Limited Warranty\*

### Apache 360 LT Track System

Maverick, Maverick MAX

715005103 **35 903 zł**



- Multifunctional tracks designed to support heavy loads and to fit on most Can-Am off-road vehicles.
- Extra contact patch adjustment for better performance over rough terrain.
- Contact patch is 7% to 9% bigger than the Apache 360's.
- Average ground clearance of 16" (41 cm).
- 1" (2.5 cm) lugs in the front and 1.25" (3.2 cm) in the back.
- Apache 360 LT Mounting Kit, Track DPS Module and Engine and CVT Pre-Filter Kit are required.
- EC compliant.

### Apache 360 LT Mounting Kit

(Not illustrated)

Maverick, Maverick MAX

715004392 · 64" models **4 238 zł**  
715004393 · 72" models **5 490 zł**

- Required for installation of the Apache 360 LT Track System.
- Track DPS Module and Pre-Filter not included.

## APACHE TRACK SYSTEMS FITTING GUIDE

### Apache Backcountry LT

Model Year / Model	Track	Track Mount	Track DPS Module	Prefilter without Snorkel	Prefilter with Snorkel
2017 & Up Maverick, Maverick MAX (64" Models)		<b>715004397</b> <b>4 712 zł</b>	<b>715007338</b> Maverick, Maverick Max 2022 & prior (except Turbo RR engine)		
	<b>715004734</b> <b>45 678 zł</b>		OR <b>715006266</b> Maverick, Maverick Max 2023, and 2022 & prior with Turbo RR Engines	<b>715005600</b> (except X mr) <b>591 zł</b>	<b>715005599</b> <b>591 zł</b>

### Apache 360 LT

Model Year / Model	Track	Track Mount	Track DPS Module	Prefilter without Snorkel	Prefilter with Snorkel
2017 & Up Maverick, Maverick MAX (64" Models)		<b>715004392</b> <b>4 238 zł</b>	<b>715007338</b> (except Turbo RR engine)		
	<b>715005103</b> <b>35 903 zł</b>		OR <b>715006266</b> (Turbo RR engine only)	<b>715005600</b> <b>591 zł</b>	<b>715005599</b> <b>591 zł</b>

\*The limited warranty is subject to the exclusions, limitations of liabilities and all other terms and conditions of BRP's standard limited warranty.

## Accessories

<b>Rail Ice Scratchers</b>	Apache Backcountry LT Track System	<b>860201728</b>	<b>538 zł</b>
	<ul style="list-style-type: none"> <li>• Provide additional lubrication in hard and icy conditions.</li> <li>• Rail mounted, small, light.</li> <li>• Design expands on coil concept to allow reversing without damage.</li> <li>• Easily stored when not in use.</li> <li>• Extends slider life.</li> </ul>		
<b>Apache Backcountry LT Wheel Kit</b>	Apache Backcountry LT Track System	<b>715006293</b>	<b>591 zł</b>
	<ul style="list-style-type: none"> <li>• Additional wheel kit for Backcountry LT rear tracks.</li> <li>• Reduces drag and rolling resistance in hard snow conditions or when transporting heavier loads.</li> <li>• Extends slider life in hard snow conditions.</li> <li>• Includes two wheels, cross shaft and mounting hardware per kit to service one track corner.</li> <li>• Up to two kits per rear track can be installed.</li> </ul>		
<b>Sliders with Vespel<sup>†</sup> Inserts</b>	Apache Backcountry LT Track Systems	<b>503194815</b>	<b>498 zł</b>
	<ul style="list-style-type: none"> <li>• Use DuPont Vespel inserts for less friction.</li> <li>• Longer life.</li> <li>• Can be cut to desired length.</li> <li>• 8 needed per vehicle.</li> <li>• Sold individually.</li> </ul>		
<b>Track DPS Module</b> <i>(Not illustrated)</i>	Maverick, Maverick MAX (Turbo RR engine only)	<b>715006266</b>	<b>512 zł</b>
	Maverick, Maverick MAX (except Turbo RR engine)	<b>715007338</b>	<b>464 zł</b>
	<ul style="list-style-type: none"> <li>• Innovative DPS module that ensures speedometer accuracy and optimized steering assist, making for perfect track control and riding ease.</li> <li>• Required to install the Apache Track Systems.</li> </ul>		
<b>Engine &amp; CVT Air Intake Pre-Filter</b>	Maverick, Maverick MAX (except X mr models)	<b>715005600</b>	<b>591 zł</b>
	<ul style="list-style-type: none"> <li>• Adds extra protection to your engine in harsh riding conditions.</li> <li>• Helps keep air filter cleaner.</li> <li>• Filter blocks particles larger than 0.007" (0.19 mm).</li> <li>• Easy installation.</li> <li>• Not compatible with S&amp;B Particle Separator.</li> <li>• Necessary to maintain vehicle warranty when tracks are installed.</li> </ul> <p><i>Required to install the Apache Backcountry LT and Apache 360 LT Track Systems.</i></p>		
<b>Snorkel Pre-Filter</b>	Maverick, Maverick MAX (with Snorkel Kit)	<b>715005599</b>	<b>591 zł</b>
	<ul style="list-style-type: none"> <li>• Pre-filter specifically for snorkels.</li> <li>• Adds extra protection to your engine in harsh riding conditions.</li> <li>• Helps keep air filter cleaner.</li> <li>• Filter blocks particles larger than 0.005" (0.13 mm).</li> <li>• Necessary to maintain vehicle warranty when tracks are installed.</li> </ul> <p><i>Required to install the Apache Backcountry LT and Apache 360 LT Track Systems.</i></p>		



# PROMOUNT PLOWS

## Can-Am ProMount Steel Plow Kits

### Can-Am ProMount Steel 72" (183 cm) Plow Kit

Maverick, Maverick MAX

■ **715008176** · Black **2 260 zł**  
 ■ **715008177** · Yellow



- These kits include:
  - Can-Am ProMount Steel Blade
  - Push Frame with Quick-Attach System
  - Can-Am ProMount Mounting Plate

## Can-Am ProMount Steel Blades

### Can-Am ProMount Steel 72" (183 cm) Blade

Fits ProMount Push Frame

■ **715004474** · Black **2 260 zł**  
 ■ **715006021** · Yellow



- Plow blade made from 12-gauge steel.
- Replaceable wear blade.
- Large pin designed for easy blade rotation to eliminate snow buildup at pivot point.
- Blade design provides best snow roll-off at any angle.
- Clears 66" (168 cm) when plow is fully angled.
- Blade height of 17" (43 cm).
- Compatible with Can-Am ProMount Blade accessories to further enhance plow versatility.
- Not compatible with S3 High Clearance Front A-Arm.

## Can-Am ProMount Angle Plows

### Can-Am ProMount 72" (183 cm) Steel Oneway State Blade

Fits ProMount Push Frame

**715007264** **2 543 zł**



- Make the job easier with the right tools, clear long alleys and make the task easier by sending the snow further out of the way.
- Wing end of plow measures 26" (67 cm) high and tapers down to 16" (41 cm).
- One-way "winged" state plow designed to throw snow higher.
- Rubber flap (715007299) designed to keep snow away from the driver is offered as accessory (sold separately).
- Can-Am branded.

## Can-Am ProMount Flex2 Plow Kit

### Can-Am ProMount Flex2 72" (183 cm) Blade

Maverick, Maverick MAX

**715008175** **2 772 zł**



- These kits include:
  - Can-Am ProMount Flex2 Blade
  - Push Frame with Quick-Attach System
  - Can-Am ProMount Mounting Plate

## Can-Am ProMount Flex2 Blades

### Can-Am ProMount Flex2 72" (183 cm) Blade

Fits ProMount Push Frame

**715004485** **2 772 zł**



- Plow blade made of UHMWPE, flexible and impact absorbing material prevents damaging your plow when accidental impact occurs.
- Replaceable wear blade.
- Large pin designed for easy blade rotation to eliminate snow buildup at pivot point.
- Blade design provides best snow roll-off at any angle.
- Clears 66" (168 cm) when plow is fully angled.
- Blade height of 17" (43 cm).
- Compatible with Can-Am ProMount Blade accessories to further enhance plow versatility.

## Can-Am ProMount Plow Accessories

<b>Can-Am ProMount Edge Markers</b>	Maverick, Maverick MAX	<b>715004206</b>	<b>218 zł</b>
-------------------------------------	------------------------	------------------	---------------

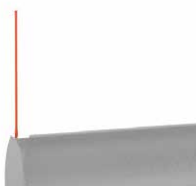

- Help locate the edges of your plow.
- Height: 24" (60 cm).
- Sold in pairs.
- Compatible with Can-Am ProMount Steel and Flex2 Blades with or without Blade Extensions (except for the Can-Am ProMount Steel 54" (137 cm) Blades).

<b>Can-Am ProMount 72" (183 cm) Plastic Wear Blade</b>	Maverick, Maverick MAX	<b>715004483</b>	<b>746 zł</b>
--	------------------------	------------------	---------------



- Ideal to prevent leaving marks on your driveway.
- Compatible with Can-Am ProMount 72" (183 cm) Blades.

<b>Can-Am ProMount Drift Cutters</b>	Maverick, Maverick MAX	<b>715006258</b>	<b>746 zł</b>
--------------------------------------	------------------------	------------------	---------------

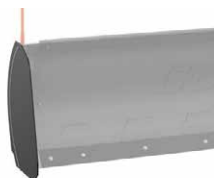

- Help keep snow in the plow.
- Dimensions: 17" x 13" (43.2 cm x 33 cm).
- Sold in pairs.
- Compatible with Can-Am ProMount Steel and Flex2 blades with or without Blade Extensions (except for the Can-Am ProMount Steel 54" (137 cm) Blades).

<b>Can-Am ProMount Blade Extensions</b>	Maverick, Maverick MAX	■ <b>715004205</b> · Black ■ <b>715005319</b> · Yellow	<b>549 zł</b>
---	------------------------	---	---------------



- These conveniently extend your Can-Am ProMount Blade.
- Add 3" (8 cm) each side.
- Compatible with Can-Am ProMount Blades (except for the Can-Am ProMount Steel 54" (137 cm) Blades).
- Longer Wear Blade can be installed to go over the extra length given by the extensions.

<b>Back Drag Blade</b> <i>(Not illustrated)</i>	ProMount Plows (60" and more)	<b>715007794</b>	<b>1 327 zł</b>
--	-------------------------------	------------------	-----------------

- ¼ thick steel swivel scraper.
- Lifts up when the vehicle is moving forward so as not to affect the scraping.
- Increased capacity to pull snow.
- More aggressive scraping in reverse mode.
- Lifts the scraper off the ground so that it scrapes evenly.
- Adjustable in length for compatibility with 60", 66" and 72" blades.
- Compatible with ProMount blades (Flex and Steel).
- Not compatible with Backcountry Track Kit.

<b>Curved Wear Blade</b> <i>(Not illustrated)</i>	Maverick, Maverick MAX	<b>715007793</b> · 72" (183 cm)	<b>544 zł</b>
--	------------------------	---------------------------------	---------------

- Wear blade designed with a folded back bottom lip.
- The increased surface allows for less digging while plowing uneven surfaces.
- Ideal for snow covered gravel, grass, paver stone and other soft surfaces.

\* Price subject to change

## Can-Am ProMount Custom Solutions

### Can-Am ProMount Push Frame with Quick-Attach System

Maverick, Maverick MAX

715008116

2 655 zł



- Heavy-duty steel tubes designed to withstand the roughest use.
- Mid-mount carriage provides ultimate push strength and traction.
- Designed for maximum plow lift height.
- Features a self-aligning quick-attach system, an easy foot release pedal and an ergonomic handle for plow angle adjustment.
- Plow Limit Switch recommended to extend winch cable lifespan.
- Can-Am ProMount Mounting Plate required for installation.
- Blade swivels left or right, 5 positions.
- Large pin designed for easy blade rotation to eliminate dirt and snow buildup at pivot point.
- Plow Roller Fairlead included.

### Can-Am ProMount Push Frame Extension

Maverick, Maverick MAX

715006257

821 zł

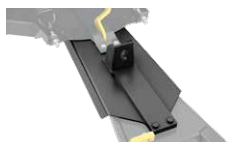

- 12" (30 cm) push frame extension required when plow is installed with Apache Track systems.

### Can-Am ProMount Mounting Plate

Maverick, Maverick MAX

715008197

1 120 zł



- Required to install the Can-Am ProMount Push Frame with Quick-Attach System.
- Mounting plate precision designed to stay on year round without compromising ground clearance.
- Comes with the Plow Roller Fairlead.
- Not compatible with S3 High Clearance Front A-Arm.

### Can-Am ProMount Plow Angling System

Maverick, Maverick MAX

715006022

7 009 zł



- Converts your plow system into an easy-to-control unit from the driver's seat.
- Allows you to have full up/down and left/right plow control at your fingertips by using the supplied joystick.
- Using one hand to control all plow motions will allow you to easily concentrate and manage your plowing tasks.
- Not compatible with Apache Backcountry LT Track System.
- Winch and plow sold separately.

### ProMount Plow Limit Switch

(Not illustrated)

Maverick, Maverick MAX

715006259

635 zł

- For controlling the cable tension when over-raising your plow system.
- Prevents winch, plow push frame and vehicle damage.
- Sensor relocated for optimal lift height.

### Plow Roller Fairlead

Maverick, Maverick MAX

715001223

416 zł



- Cylindrical Roller Fairlead
- Larger diameter lower roller reduces wear on wire rope for plow application.
- Can be used with all ProMount plows.

## ProMount Plow Kits – Reference Charts

	72" Black Steel	72" Yellow Steel	72" Flex2
Plow Kit	715008176	715008177	715008175
Blade	715004474	715006021	715004485
Push Frame	715008116	715008116	715008116
Mounting Plate	715008197	715008197	715008197

# TIRES & RIMS

## Tires

### Maxxis<sup>†</sup> Bighorn 2.0 Tire



- Front · 28" x 9" x 14".
- Rear · 28" x 11" x 14".
- Compliant with European class T regulations.
- Front · 27" x 9" x 14".
- Rear · 27" x 11" x 14".

705402080 · Front	1 061 zł
705502603 · Rear	1 104zł
705402168 · Front · (C€)	997 zł
705502665 · Rear · (C€)	1 040 zł

### Maxxis Liberty Tire



- Engineered for performance driving and to give you and your side-by-side freedom in a variety of terrains.
- 8-ply radial construction.
- Front: 30" x 10" x 14".
- Rear: 32" x 10" x 15".

Maverick X rc

705402143 · Front	1 429 zł
705402464 · Rear	1 514 zł

### Maxxis Carnivore Tire



- The Carnivore boasts a gnarly tread design that delivers excellent traction on rocks, roots, desert terrain, and mud. The Carnivore is designed to conquer a wide variety of terrains.
- Aggressive all-terrain tread pattern.
- 8-ply-rated radial construction.
- Front & Rear · 30" or 32" x 10" x 14".

Maverick (except X mr, X rc & X rs models)

705402960 · 30"	1 429 zł
705402961 · 32"	1 514 zł

### Maxxis Bighorn X ds Tire

(Not illustrated)

- Front · 29" x 9" x 14".
- Rear · 29" x 11" x 14".

705402081 · Front	1 146 zł
705502604 · Rear	1 189 zł

### Maxxis Bighorn X rs Tire

(Not illustrated)

- Front & Rear · 30" x 10" x 14".

705402082	1 274 zł
-----------	----------

## Rims

### 14" Maverick X mr Rim



- Black with clear coat aluminum rim.

Maverick, Maverick MAX

705402256	1 169 zł
-----------	----------

### 14" Maverick Beadlock Rim



- Black aluminum rim with machined face and clear coat.
- Choice of beadlock color (not included).
- Needs 16 bolts (250000893) for installing the beadlock.

Maverick, Maverick MAX

■ 705402207	1 169 zł
• Black and machined	
■ 705402173 · Black	1 200 zł



**14" Maverick Rim**

Maverick, Maverick MAX

**705401965** · Front

**707 zł**

**705502493** · Rear



- Black with clear coat aluminum rim.
- Front: 14" x 7" Offset = 55 mm.
- Rear: 14" x 8" Offset = 76 mm.

**14" Maverick Beadlock Rim**

Maverick, Maverick MAX

**705402393** · Front

**1 193 zł**

**705502814** · Rear

**1 267 zł**



- Black with clear coat aluminum rim.
- Choice of beadlock color.
- Needs 16 bolts (250000893) for installing the beadlock.
- Front: 14" x 7" Offset = 55 mm (For Xrs = Front and rear).
- Rear: 14" x 8" Offset = 76 mm.

**14" Maverick Beadlock Ring**

Maverick & Maverick MAX (X rs, X ds models only)

■ **705401709** · Black

**462 zł**

■ **705401913** · Gold

**505 zł**

■ **705402358** · Can-Am Red

**462 zł**

■ **705402472** · Manta Green

**505 zł**



- Cast aluminum beadlock.
- Must be installed on Front Rim (705402393) and Rear Rim (705502814).

# TRUST GENUINE CAN-AM PARTS

To keep your vehicle performing at its best.

## BRP 2-YEAR LIMITED WARRANTY\*

Precisely engineered.  
Rigorously tested.  
Factory approved.

The limited warranty is subject to the exclusions, limitations of liabilities and all other terms and conditions of BRP's standard limited warranty. See the complete limited warranty applicable to your product, or contact your authorized Can-Am Off-Road dealer. Applicable only to BRP products purchased at authorized BRP dealers or distributors. This limited warranty may not apply to factory-installed parts and accessories. Always refer to the product-specific limited warranty. Some states and provinces do not allow for some disclaimers, limitations and exclusions and, as a result, you have other specific rights.



# CAN-AM MAVERICK



To make sure your Maverick performs as you expect,  
**keep an eye on these components:\*\***

## **OIL FILTER** 420956123

### **ENGINE OIL\***

#### **4T 10W-50 Synthetic Oil**

1 quart / 946 ml 9779234  
1 US gallon / 3.785 L 9779235

#### **4T 0W-40 Synthetic Oil**

1 quart / 946 ml 9779139  
1 US gallon / 3.785 L 9779140

#### **4t 5w-40 Synthetic Blend Oil**

1 quart / 946 ml 9779133  
1 US gallon / 3.785 L 9779134

### **OIL CHANGE KIT\*\***

#### **5W-40 Synthetic Blend Oil**

900 ACE 9779260

#### **10W-50 Synthetic Oil**

900 ACE 9779261

### **FUEL FILTER**

Non-EVAP models 709001120

EVAP models 513033719

## **AIR FILTER**

### **Performance Air Filter**

by Twin Air 715002895

**Premium Air Filter** 715900422

**CVT AIR FILTER** 420450405

**DRIVE BELT** 422280652

### **METALLIC BRAKE PADS**

Front Left 715900379

Rear Left 715900386

Front Right 715900380

Rear Right 715900387

## **CV BOOT KITS**

Rear Wheel & Differential Side 715900450

Front Wheel & Differential Side 705401354

**WHEEL BEARINGS** 293350141

### **BALL JOINTS**

Upper 706203084

Lower 706202045

**SPARK PLUG** 415130363

### **BATTERY**

18 Amps. Wet (YTX20L-BS) 410301203

\* For Europe, please check correspondent part numbers on page 48.  
\*\*Refer to periodic maintenance chart for proper intervals.

Cennik zawiera sugerowane ceny detaliczne brutto w walucie PLN. Ceny mogą ulec zmianie bez wcześniejszego uprzedzenia.  
Cennik nie jest ofertą w rozumieniu prawa.

# GENUINE PARTS

## Oil Filters

Oil Filters	Models	Oil Filter	Sealing Ring (Oil Filter Cover)	Sealing Ring (Drain Plug)
	Maverick	420956123 70 zł	420230923 23 zł	420552280 18 zł
	Maverick Trail & Sport	420256188 70 zł	420230923 23 zł	420552280 18 zł
	G2S, G2 & G2L	420256188 70 zł	420230923 23 zł	420552280 18 zł

Complete Engine Oil Change Kit also available — see page 56

## Air Filters

Premium Air Filter	Models	
	Traxter/Traxter MAX	715900394 230 zł
	Maverick	715900422 224 zł
	Maverick Trail & Sport (Engines 700 & 1000)	715900394 230 zł
	Maverick Trail & Sport (Engine 1000R)	715900422 224 zł
	G2S, G2 & G2L	707800371 249 zł

- Premium quality filter.
- Prevents airborne contaminants from reaching your engine.
- Protects internal components against premature wear.

Performance Air Filter by Twin Air <sup>†</sup>	Models	
	Maverick	715002895 529 zł
	Maverick Trail & Sport	715002895 529 zł
	G2S, G2 & G2L	715001333 394 zł

- The best choice for the harshest conditions.
- Multiple staged oiled filtering foam for superior dust retaining capacity with high air flow.
- Washable and reusable.

CVT Air Filter (Not illustrated)	Models	
	Traxter/Traxter MAX (except X mr)	706600419 91 zł
	Maverick	706600416 287 zł
	Maverick Trail & Sport (except X mr)	706600417 199 zł
	Maverick Trail & Sport X mr	706600418 242 zł
	G2, G2L	715003483 246 zł
	G2S	707001786 87 zł



## Spark Plug

Spark Plug	Models	
	Traxter HD10	715900244
	Traxter HD9	715900642
	Traxter HD7	715900785
	Maverick and Maverick Turbo RR	415130363
	Maverick Trail & Sport 1000R	715900244
	Maverick Trail & Sport 1000	715900642
	Maverick Trail 700	715900785
	ATV 450/850/1000R	715900352
	ATV 570/650/1000	715900642

## Batteries

### Yuasa† Batteries

• Top of the line models from the leading preferred original equipment battery supplier in North America.



Models	3 A Wet (YTX4L-BS)	10 A Wet (YTX12-BS)	18 A Wet (YTX20L-BS)	30 A, requires Battery Holder (715004431)
Traxter/Traxter MAX	—	—	296000444	515176151 Except Base and DPS models.
Maverick	—	—	296000444	—
Maverick Trail & Sport	—	—	296000444	—
G2S, G2 & G2L	—	—	296000444	—
DS 50, 70 & 90	V31500MAA020	—	—	—
Renegade 70,110	V31500MAA020	—	—	—
DS 250	—	715900031	—	—

## Axles

### Premium CV Axle

- Premium quality design ideal for off-roading, heavy-duty and low speed torque usage.
- Includes CVs, shaft and boots with the best suited geometry for your Can-Am vehicle.



Models	Front Left	Front Right	Rear
Traxter MAX	705401937	705401936	705502451
Traxter XT-P	705402353	705402353	705502451
Traxter HD10	705401937	705401936	705502451
Traxter HD9	705401937	705401936	705502451
Traxter HD7	705401937	705401936	705502478 (L) 705502479 (R)
Maverick Sport (ABS)	705402443	705402443	705502756
Maverick Sport Base, DPS	705402031	705402030	705502552
Maverick Trail (W/O ABS)	705402008	705402007	705502541
Maverick Trail (ABS)	705402442	705402442	705502755

All ATVs: Please contact your dealer or visit our online store at [can-amoffroad.com](http://can-amoffroad.com) for suggested fitment.

### Performance CV Axle

(Not illustrated)

- High-performance design ideal for off-road use with superior wheel power and acceleration for racing, dunes, trails and desert riding.
- Includes CVs, shaft and boots with the best suited geometry for your Can-Am vehicle.

Models	Front Left	Front Right	Rear
Traxter X mr	705402420	705402420	—
Maverick Sport X mr/X rc	705402282	705402282	705502757

## Brakes

### Metallic Brake Pad Kit

- Built strong to last long – heavy-duty construction stands up to hard braking.
- Designed to handle demanding riding conditions with challenging braking environments such as mud and dunes.
- Created specifically for use with Can-Am vehicles.



Models	Front Left	Front Right	Rear Left	Rear Right
Traxter MAX HD9/HD10	715900379	715900380	715900386	715900387
Traxter HD10	715900379	715900380	715900381	715900382
Traxter HD9	715900379	715900380	715900381	715900382
Traxter HD7	715900379	715900380	—	715900387
Maverick	715900379	715900380	715900386	715900387
Maverick Trail & Sport	715900379	715900380	715900386	715900387
G2S, G2 & G2L	715900248	715900249	715900248	715900249

Please contact your dealer or visit our online store at [Can-Amoffroad.com](http://Can-Amoffroad.com) for suggested fitment.

## Parts

### A-Arm Bushing Kit

703500875

- This bushing kit includes 2 bushings, a sleeve and a wear plate, as illustrated.
- All you need to renew your suspension A-Arms.



### Ball Joints

- Robust design for off-road usage and sealed for prolonged durability.



Upper

706202044

Upper (Maverick, Trail & Sport)

706203084

Lower

706202045

### Wheel Bearings

(Not illustrated)

- Sealed bearings for additional protection from water and dirt.

2020 models and prior

293350118

2021 & up models

293350126

Maverick

293350141

### CV Boot Kit

- Comes with clamps and grease.
- Genuine BRP CV Boot Kits ensure absolute compatibility and a perfect fit.



Models	Front Wheel Side	Front Differential Side	Rear Wheel & Differential Side
Traxter	705401345	705401355	705501864
Maverick	705401354	705401354	715900450
Maverick Sport (ABS, X xc, X mr, X rc)	705401354	705401355	705501864
Maverick Sport (w/o ABS), Maverick Trail	705401345	705401355	705501864
G2, G2L, G2S (except X mr)	705401345	705401346	705501864
X mr	705401354	705401355	705501864

## Belts

### BRP Premium Drive Belt

- High-performance design ideal for off-road use.
- BRP-specific calibration adjusted to best suit your Can-Am vehicle.



Models	Premium Belt	CVT Gasket Cover	Upgrades
Traxter HD10	422280652	420450400	—
Traxter HD9	422280656	420450400	422280652
Traxter HD7	422280225	—	—
Maverick	422280652	420450405	—
Maverick Trail & Maverick Sport 1000	422280656	420450400	422280652
Maverick Trail 700	422280225	—	—
G2, G2S 450 CC & less	422280283	420430126	—
G2, G2S 500 CC & more	422280366	420430126	—
G2L Outlander 450 & Outlander MAX 450	422280283	420630292	—

### Driven Pulley Adapter Tool

(Not illustrated)

- Spreads the secondary clutch open for easy belt replacement.

### Puller/Locking Tool

(Not illustrated)

- Allows you to spread the secondary clutch open for easy belt replacement.

Models	Driven Pulley Adapter	Puller/Locking Tool
Traxter HD10-HD9	708200720	529000088
Traxter HD7	—	529036098
Maverick Trail & Sport	708200720	529000088
Maverick	708200720	529000088
G2, G2S	—	529036098
G2L Outlander 450 & Outlander MAX 450	—	529036098

## pDrive Pulley Service kits

### Ramp Roller Maintenance Set

SSV pDrive (MY22)  
SSV pDrive (MY23)

420629231

Coming winter 2023

pDrive Ramp Roller Set



### Torque Roller Maintenance Set

SSV pDrive (MY22)  
SSV pDrive (MY23)

420629224

Coming winter 2023

pDrive Torque Roller Set





# LUBRICANT & OIL CHANGE KIT

## Lubricant

### XPS 4T 10W-50 Synthetic Oil

9779234 · 1 qt / 946 ml US  
9779240 · EU

9779235 · 1 US gal / 3.785 L



- Engineered for heavy-duty and high-performance 4-stroke engines, including turbocharged, supercharged and racing engines.
- Formulated using carefully selected and strenuously tested base stocks and custom additives.
- Offers thick film strength to protect bearings, and a proven high-temp detergency to minimize deposits, prevent shear, provide thermal stability, and combat fuel dilution to ensure maximum performance from your engine.

### XPS 4T 0W-40 Synthetic Oil

9779139 · 1 qt / 946 ml US  
9779286 · EU

9779140 · 1 US gal / 3.785 L US  
9779287 · EU



- Powersport formula with premium anti-wear and anti-corrosion additives.
- The best choice for high-performance snowmobile, ATV and SXS 4-stroke engines used in cold weather.
- Provides superior engine and transmission protection against heat, rust and corrosion.
- Delivers optimal performance in high and low temperatures.

### XPS 4T 5W-40 Synthetic Blend Oil

9779133 · 1 qt / 946 ml US  
9779290 · EU

9779134 · 1 US gal / 3.785 L US  
9779291 · EU



- Off-road formula with premium anti-wear and anti-corrosion additives.
- Designed for high-performance off-road, on-road and PWC 4-stroke engines, including turbo or supercharged powersports engines.
- Provides superior engine and transmission protection against rust and corrosion, even in extreme conditions.

## Oil Change Kit

### Engine Oil Change Kit

#### Models



- Ultra-convenient "all-in-one" Engine Oil Change Kit saves time and money.
- Includes XPS Synthetic or Synthetic Blend Oil, oil filter, O-rings and washer.

5W-40 Synthetic Blend Oil / 450cc or less	9779256 · US 9779408 · EU
0W-40 Synthetic Oil / 450cc or less	9779257 · US 9779409 · EU
5W-40 Synthetic Blend Oil / 500 cc or more V-twin engine	9779258 · US 9779405 · EU
0W-40 Synthetic Oil / 500 cc or more V-twin engine	9779259 · US 9779406 · EU
10W-50 Synthetic Oil / 500 cc or more V-twin engine	9779252 · US 9779401 · EU
5W-40 Synthetic Blend Oil / 900 ACE	9779260 · US 9779410 · EU
10W-50 Synthetic Oil / 900 ACE	9779261 · US 9779411 · EU

# MAINTENANCE PRODUCTS

## Synthetic Gear Oil



- Uses custom additives to provide the best performance in Visco-Lok™ and Smart-Lok™ differentials.
- Allows higher loads, superior shear stability and reduced oxidation.
- Exceptional wear protection and superior performance at all operating temperatures.

75W-90

**9779158** · 1 qt / 946 ml US

**9779212** · EU

75W-140

**9779160** · 1 qt / 946 ml US

**9779215** · EU

## Extended Life Pre-Mixed Coolant



- Antifreeze/coolant contains the correct dilution and the necessary additives to prevent corrosion and inhibit cavitation in BRP cooling systems.
- Long-life, 5-year formula specially formulated for BRP vehicles.
- Superior heat transfer.
- Ideal replacement for vehicles that normally use a 2-year antifreeze/coolant (green).
- 5 years (orange).

**9779150** · 1 qt / 946 ml

**619590204** (Scandinavia)

## Anti-Corrosive Lubricant



- Multipurpose lubricant that can also be used to prevent rust, corrosion and moisture intrusion.
- It contains extreme pressure additives that work as an all-around lubricant for just about anywhere lubrication is needed.

**9779167** · 12 oz / 340 g

**619590722** (Scandinavia)

## DOT 4 Brake Fluid



- Meets or exceeds all DOT3 and DOT4 brake fluid requirements.
- High-temperature formula resists fade and also conditions seals and O-rings in braking system.

**9779151** · 12 fl oz / 355 ml US

**9779207** · EU

# CARE PRODUCTS

## Cleaner and Degreaser, All Purpose

9779328 · 22 fl oz / 650 ml

9779329 · 2 qt / 1.89 L



- Ready-to-use formula.
- Cleans toughest dirt and grime.
- Phosphate free eco-friendly formula.
- Low-foam easy rinse formula.

## Matte Finish Waterless Cleaner

9779330 · 22 fl oz / 650 ml



- Easy waterless use.
- Perfect for matte, flat and denim surfaces.
- Contains no wax or silicone.
- Leaves no unwanted streaks or marks.

## Multi-Surface and Glass Cleaner

9779331 · 22 fl oz / 650 ml



- Easy waterless spray and wipe use.
- Polymer formula cleans and protects.
- Contains no wax or silicone.
- Leaves no unwanted streaks or marks.

## Mud and Dust Off-Road Wash

9779340 · 33 fl oz / 946 ml

9779341 · 2 qt / 1.89 L



- Specially formulated for off-road vehicles, it breaks the bond holding grime and dirt to your vehicle's finish.
- The formula is biodegradable, eco-friendly with no phosphates or corrosive chemicals and is low foam for easy, quick rinsing.
- Effective on oil, grease and other stubborn grime.
- Safe for use on all surfaces.

## Black Plastic and Rubber Restorer

9779335 · 7.6 fl oz / 225 ml



- Restores plastic, rubber and vinyl.
- Long-lasting formula.
- Protects against UV rays.

## Foaming Wash

9779337 · 16 fl oz / 473 ml

9779338 · 2 qt / 1.89 L



- Concentrated formula for off-road vehicles, it produces a thick foam to lift dirt and prevent scratching.
- The pH neutral formula is safe for wax and paint sealants.
- Works in pressure washers or by hand.

## Quick Detailer Gloss Enhancing

9779332 · 4 fl oz / 118 ml

9779333 · 16 fl oz / 473 ml



- Quick detail spray wax.
- Leaves a high gloss finish at every wipe.
- Nanotechnology polymer formula.
- Repels dirt.
- No water needed.

Quady Śrem - tel. 61 28 35 657 - email: [biuro@sklepatv.pl](mailto:biuro@sklepatv.pl) - [www.sklepatv.pl](http://www.sklepatv.pl)

EXPLORE AN ENTIRE WORLD OF ADVENTURE WITH ALL OF OUR BRP PRODUCTS. **BRP.COM**



**ski-doo LYNX SEA-DOO CAN-AM ROTAX ALUMACRAFT Manitou QUINTREX**

Cennik zawiera sugerowane ceny detaliczne brutto w walucie PLN. Ceny mogą ulec zmianie bez wcześniejszego uprzedzenia. Cennik nie jest ofertą w rozumieniu prawa.





[CAN-AMOFFROAD.COM](http://CAN-AMOFFROAD.COM)



Cennik zawiera sugerowane ceny detaliczne brutto w walucie PLN. Ceny mogą ulec zmianie bez wcześniejszego uprzedzenia. Cennik nie jest ofertą w rozumieniu prawa.